



# AURORA<sup>®</sup> UNO

## Photovoltaic Inverters

### PVI-5000/6000-TL



---

## Technical Manual

---

Copyright © 2013 Power-One, Inc. All rights reserved. No part of this document may be reproduced in any form without the prior written permission of Power-One. Power-One makes no representations or warranties, express or implied, with respect to the contents of this document. Power-One reserves the right to make changes to this document without notice and shall not be responsible for any damages caused by reliance on the content presented. All trademarks, logos, trade names, service marks and copyrighted materials used in this document are the property of their respective owners. The Power-One name and logo are registered trademarks of Power-One, Inc. in the U.S.A. and other countries.

# Contents

---

<b>PART 1</b>	<b>INTRODUCTION &amp; SAFETY .....</b>	<b>3</b>
1.1	INTRODUCTION.....	3
1.2	SAFETY .....	4
1.3	ARC FAULT DETECTION (AFD) .....	9
1.4	AVAILABLE VERSIONS .....	9
<b>PART 2</b>	<b>UNPACK AND SELECT INSTALLATION LOCATION .....</b>	<b>12</b>
2.1	TRANSPORTATION AND HANDLING.....	12
2.2	SELECT INSTALLATION LOCATION .....	13
<b>PART 3</b>	<b>MOUNTING &amp; WIRING.....</b>	<b>16</b>
3.1	WALL MOUNTING.....	16
3.2	WIRING DETAILS .....	17
3.3	ELECTRICAL CONNECTIONS .....	23
<b>PART 4</b>	<b>OPERATIONS GUIDE .....</b>	<b>32</b>
4.1	MONITORING AND DATA TRANSMISSION .....	32
4.2	COMMISSIONING.....	36
4.3	DESCRIPTION OF THE MENUS .....	40
4.4	USING THE AURORA® MANAGER-TL SOFTWARE .....	50
4.5	ADJUSTMENTS OF DISCONNECTION PARAMETERS.....	54
<b>PART 5</b>	<b>TROUBLESHOOTING GUIDE.....</b>	<b>58</b>
5.1	ARC FAULT DETECTION SELF-TEST ERRORS (-A MODELS ONLY) .....	58
5.2	DISPLAY MESSAGES AND ERROR CODES.....	59
5.3	THE POWER ONE SERVICE CALL .....	67
<b>PART 6</b>	<b>MAINTENANCE GUIDE.....</b>	<b>68</b>
6.1	POWER-DOWN PROCEDURES .....	68
6.2	ROUTINE MAINTENANCE.....	69
6.3	CR2032 LITHIUM BATTERY REPLACEMENT .....	69
6.4	STORAGE AND DISMANTLING.....	70
<b>PART 7</b>	<b>APPENDIX.....</b>	<b>71</b>
7.1	DATA SHEETS.....	71
7.2	SYSTEM DESCRIPTION.....	78
7.3	INDEX OF FIGURES AND TABLES.....	83

---

# PART 1 INTRODUCTION & SAFETY

---

## 1.1 INTRODUCTION

This manual contains important instructions for the Power-One AURORA® UNO Inverter transformerless models indicated on the front cover of this manual that shall be followed during installation and maintenance of the inverter.

**THE INSTALLER MUST READ THIS DOCUMENT IN ITS ENTIRETY BEFORE INSTALLING OR COMMISSIONING THIS EQUIPMENT.**

### 1.1.1 PURPOSE

The purpose of this document is to support the qualified technician, who has received training and/or has demonstrated skills and knowledge in construction, to install and maintain this Power-One AURORA® UNO Photovoltaic (PV) Inverter.

This manual does not cover any details concerning equipment connected to the inverter such as the solar modules. Information concerning the connected equipment is available from the respective manufacturer.

### 1.1.2 MAINTENANCE AND SERVICE

Maintenance and service procedures must comply with the manufacturer's documentation, which includes this manual, written warranty information and where applicable, a master supplier agreement (MSA). For more detailed information, see Maintenance, Part 6. Call Power-One Customer Service at 877-261-1374 for a list of qualified service contractors.

### 1.1.3 FIGURES AND IMAGES IN THIS MANUAL

The photos in this manual may differ slightly from the final model shipped and the color of the components may not match those illustrated; however the information is still applicable.

### 1.1.4 WARRANTY INFORMATION

After inspecting the AURORA UNO Inverter, it is necessary to fill out the warranty information on this unit and submit it to Power-One. Submitting this information will register the unit with the manufacturer and the owner will receive technical updates regarding this Power-One photovoltaic inverter.

Warranty Conditions can be found on the Power-One Renewable Energy website located in the download section of the AURORA UNO inverter product page.

### 1.1.5 ADDITIONAL INFORMATION

More information on Power-One's AURORA UNO Inverter can be found at [www.power-one.com](http://www.power-one.com).





## 1.2 SAFETY

### IMPORTANT SAFETY INSTRUCTIONS!

### SAVE THESE INSTRUCTIONS – KEEP IN A SAFE PLACE!





#### 1.2.1 WARNINGS IN THIS DOCUMENT

This is a list of special safety symbols used in this manual that highlight potential safety risks and/or useful information. These symbols are as follows:

Symbol	Usage
	<b>DANGER</b> Indicates a hazardous situation that can result in deadly electric shock hazards, other serious physical injury, and/or fire hazards.
	<b>WARNING</b> Indicates directions which must be fully understood and followed in entirety in order to avoid potential safety hazards including equipment damage, or personal injury. The reader should stop, use caution and fully understand the operations explained before proceeding.
	<b>WARNING DANGEROUS VOLTAGE</b> The product works with high voltages. All work on the AURORA Inverter must follow the described documentation and must comply with all prevailing codes and regulations associated with high voltages. During inverter operation, parts will be energized at voltage levels.
	<b>WARNING HOT TEMPERATURE</b> Some surfaces may become hot. Do not touch the product while it is in operation.
	UL 1741 Standard for Safety for Inverters, Converters, Controllers and Interconnection System Equipment for use with Distributed Energy Resources. CSA CSA-C22.2 No. 107.1-01 - General Use Power Supplies.

### 1.2.1.1 EQUIPMENT SAFETY WARNINGS

In addition to the safety and hazard symbols, the following symbols are also used in this installation guide:

	System earth conductor (main grounding protective earth, PE)
	Alternating Current (AC) Value
	Direct Current (DC) Value
	Phase
	Grounding (earth)

The equipment has various labels. Those with a yellow background refer to safety concerns. Be sure to read all labels before beginning installation of the equipment. If any questions arise as to the meaning or intent of these notices, please contact Power-One Technical Support at 1-877-261-1374.

### 1.2.1.2 General Installation Warnings

The AURORA UNO Transformerless Inverter is designed and tested according to international safety requirements; however, certain safety precautions must be observed when installing and operating this inverter. Read and follow all instructions, cautions and warnings in this installation manual. If questions arise, please contact Power-One Technical Support at 1-877-261-1374.



All operations regarding transport, installation and start-up, including maintenance must be carried out by qualified, trained personnel and in compliance with all prevailing local codes and regulations.

### 1.2.1.3 Assembly Warnings

Prior to installation, inspect the unit to ensure absence of any transport or handling damage, which could affect insulation integrity or safety clearances; failure to do so could result in safety hazards.

Assemble the inverter per the instructions in this manual. Use care when choosing installation location and adhere to specified cooling requirements.

Unauthorized removal of necessary protections, improper use, incorrect installation and operation may lead to serious safety and shock hazards and/or equipment damage.

#### 1.2.1.4 Electrical Connection Warnings

This grid-tied inverter system operates only when properly connected to the AC utility grid. Before connecting the services of the AURORA grid-tied inverter to the AC utility grid, contact the local power distribution company to receive the appropriate approvals. This connection must be made only by qualified technical personnel.



**Wiring methods used should be in accordance with the National Electric Code, ANSI/NFPA 70 (NEC), Canadian Electric Code (CEC), and/or other local codes and regulations.**



**WARNING:** To reduce the risk of fire, connect only to a circuit provided with 25A, 30A, 35A for PVI-5000-OUTD-US(-A) or 30A, 35A, 40A for PVI-6000-OUTD-US(-A) maximum branch circuit overcurrent protection in accordance with the National Electric Code (ANSI/NFPA 70). See Maximum AC OCPD requirement in Appendix, Table 7-1.

The AURORA UNO inverter should be connected only to a dedicated branch circuit. Power-One DOES NOT provide AC output overcurrent protection; it is the responsibility of the end user to provide protection for the AC output circuit..



All photovoltaic source and output circuit conductors shall have disconnects complying with the NEC, Section 690, Part III. A DC switch should be inserted when not integrated in the inverter. The –S and –A models have an integrated DC switch.

#### 1.2.2 SAFETY INSTRUCTIONS



**Warning** – These servicing instructions are for use by qualified personnel only. To reduce the risk of electric shock, do not perform any servicing other than that specified in the operating instructions.



**Danger** - Be sure all flammable materials including construction items are away from the unit. Do not install the inverter in or near potentially explosive areas.



**CAUTION** - The AURORA is designed without an isolation transformer and is intended to be installed per NFPA 70, 690.35 with an ungrounded PV array. These models have no grounded input conductors.



The installer and/or operator must properly protect the installation from access by the public and/or highlight with signs or notices the potential hazards of the equipment, e.g., magnetic fields, hazardous voltages, high temperatures, possibility of discharges, generic hazard, etc.

### 1.2.2.1 *General Information*

The equipment has been manufactured in accordance with the strictest accident-prevention regulations and supplied with safety devices suitable for the protection of components and operators. . Inform the manufacturer about non-standard installation conditions.

Maintenance operations must be carried out according to the Maintenance section in Part 6 of this manual.

It is essential to provide operators with correct information. They must therefore read and comply with the technical information given in the manual and in the attached documentation.

The instructions given in the manual do not replace the safety devices and technical data for installation and operation mounted on the product. They do not replace the safety regulations enforced in the country of installation and common sense rules.

Do not use the equipment if any operating anomalies are found. Avoid temporary repairs.

All repairs should be carried out using only qualified spare parts, which must be installed in accordance with their intended use and by a licensed contractor or authorized Power-One Service representative.

Liabilities arising from commercial components are delegated to their respective manufacturers.

### 1.2.2.2 *Thermal Hazard*



**WARNING** - Depending upon ambient temperatures during operation and immediately following shut down, surface temperatures on the cooling fins (heat sink) and some areas of the chassis may be extremely hot to the touch.

Prior to touching any part of the inverter use care to ensure surfaces and equipment are at touch-safe temperatures and voltages before proceeding.

Anytime the inverter has been disconnected from the AC utility grid, use extreme caution as some components can retain charge sufficient to create a shock hazard and may need time to dissipate the charge. To minimize occurrence of such conditions, comply with all corresponding safety symbols and markings present on the unit and in this manual.

### 1.2.2.3 *Location Of Safety Notices*

Note the location of safety notices on the AURORA UNO Inverter for notification and protection. They are located on both side panels of this unit.

Labels must not be hidden with external objects or parts such as rags, boxes, or other such equipment. They should be cleaned periodically and always maintained in view.

#### 1.2.2.4 *Clothing and Protective Devices*

Appropriate Personal Protective Equipment (PPE) must be worn at all times when servicing this equipment under any conditions which may subject personnel to hazardous voltages or temperatures that are not touch-safe.

All operations on the equipment should be performed with properly electrically insulated instruments.

### 1.2.3 APPROPRIATE USAGE

The AURORA Inverter is a photovoltaic inverter that converts direct current of a connected PV array into alternating current and feeds that power into the AC utility grid.

This AURORA Inverter is designed for outdoor use, but can be used indoors if installed to specified environmental and mounting parameters stated in this manual, and adherence to the National Electric Code. (See Environmental Conditions below and General Installation Conditions in section 2.2.1 for more information.)

#### 1.2.3.1 *Conditions of Use*



**This inverter utilizes a transformerless design and requires connected array(s) to be floating with respect to ground; it can be used only with photovoltaic modules that do not require one of the terminals to be grounded.**

The DC and AC operating currents **MUST NOT** exceed the limits documented in the technical specifications.

The inverter is certified for use only with photovoltaic arrays connected to its input channel(s). Do not connect batteries or other types of power sources.

The inverter can be connected to the utility grid in qualified countries only.

The inverter can only be used if all the technical requirements in this manual are observed and applied.

#### 1.2.3.2 *Environmental Conditions*

Adverse environmental conditions can lead to a reduction in performance. The equipment should be installed outdoors, but only in environmental conditions indicated in this manual. Care must be taken to provide adequate ventilation if installed indoors.

#### 1.2.3.3 *Improper or Prohibited Use*

The following actions are dangerous, not consistent with acceptable practice and will negate the product warranty if implemented:

- Installing the equipment in environments with flammable conditions.
- Using the equipment with safety devices not working or disabled.
- Using the equipment or parts of the equipment by connecting it to other machines or equipment, unless otherwise expressed.
- Modifying areas that are operator restricted and/or altering parts of the equipment in order to vary the performance or change its protection.



- Cleaning with corrosive products that may corrode parts of the equipment or with products that might generate electrostatic charges.
- Using or installing the equipment or parts of it without having read and correctly interpreted the contents of this manual.
- Blocking airflow to the cooling fins (e.g., warming or drying rags) on the unit or accessory parts is dangerous and could compromise the inverter operation due to overheating.

### 1.3 ARC FAULT DETECTION (AFD)

The 2011 National Electric Code (NEC) and 2013 Canadian Electric Code (CEC) includes a new condition that requires a photovoltaic system with a DC voltage greater than 80V, and which is on a building or whose DC conductors enter a building, must be equipped with a Listed device which can detect a DC arc fault and interrupt the circuit. This functionality is commonly referred to as a DC AFCI.

Power-One's DC ARC FAULT DETECTOR and INTERRUPTOR (AFDI) solution is based on Digital Signal Processor (DSP) technology. The AFDI module has two independent channels, designed to accommodate the two independent MPPT channels associated with all Aurora String inverters, and has two current sensors and associated circuitry to identify the presence of a series DC arc fault at the input of either inverter MPPT channel.

The DC AFDI module performs a self-test every time the system is started and the inverter display shows the result, which can only be pass or fail. If it fails, an error code will be displayed and the inverter will not connect to the grid. If it passes, the inverter connects and operates normally.

If a DC arc fault is detected during normal operations, the inverter disconnects from the AC grid. The DC arc fault error is indicated on the inverter display screen and lock out of inverter operation is initiated until the fault is manually reset.



**Refer to section 5.2, ARC FAULT DETECTION SELF-TEST ERRORS (-A MODELS ONLY), for display error messages and instructions to reset fault conditions or manually start the self-test procedure.**

### 1.4 AVAILABLE VERSIONS

This document applies only to the following **transformerless** inverter models which can be divided into two groups according to their rated output power of 5.0 kW or 6.0 kW.

5.0 kW	PVI-5000-OUTD-US	<ul style="list-style-type: none"><li>• <b>Unit Weight: 59.5 lbs/27 kg</b></li><li>• <b>Shipping Weight: 78 lbs/35.4 kg</b></li><li>• <b>Dimensions H x W x D):</b> 41.4" x 12.8" x 8.6" / 1052mm x 325mm x 218mm</li></ul>
	PVI-5000-OUTD-US-A	
6.0 kW	PVI-6000-OUTD-US	
	PVI-6000-OUTD-US-A	

For inverters of equal output power, the differences between models are the presence of Arc Fault Detection. A description of the two models can be found in Table 1-1

Table 1-1: Available versions

<b>PVI-5000/6000-OUTD-US</b>	Wiring box with integrated DC Disconnect Switch
<b>PVI-5000/6000-OUTD-US-A</b>	Wiring box with integrated DC Disconnect Switch and Integrated PV AFCI Type 1 device for arc fault detection (AFD)* <b>Section 1.3</b>

### 1.4.1 PRODUCT NAMEPLATE

The product nameplate is affixed to the inverter and provides the following information:

1. Product origin
2. Model name
3. DC input data
4. AC output data
5. Certification

Technical data reported in this manual does not substitute the data mentioned on the labels affixed to the equipment.

**power-one**  
Assembled in USA

**5** **US**  
UL 1741  
CSA-C22.2 No. 107.1-01

**PHOTOVOLTAIC GRID TIED INVERTER**  
**UTILITY INTERACTIVE**  
**MODEL: PVI-5000-OUTD-US**

<b>3 DC RATING</b>	
Nominal Input Operating Voltage	360 V ===
Max. Input Voltage	600 V === (†)
Range of Input Operating Voltage	90 - 580 V === (†)
Range of Input Voltage @Full Power	200 - 530 V === (†)
Max. Input Current	18 A (†)(‡)
Max. Input Short Circuit Current (P.V. Panels)	22 A (†)(‡)

<b>4 AC RATING</b>	
Nominal Output Voltage	277 V~ / 240 V~ / 208 V~ 1Ø
Operating Voltage Range	244-304 V~ / 211-264 V~ / 183-228 V~
Nominal Output Frequency	60 Hz (factory preset)
Operating Frequency Range	59.3(†)-60.5(†) Hz
Output Power Factor	>0.995
Max. Output Current, for each phase	20 A / 23 A / 27 A (rms)
Max. Continuous Output Power	5000 W @ 60°C amb.
Max. Output Overcurrent Protection	25 A / 30 A / 35 A

Operating Ambient Temperature: -25 to +60 °C (-13 to +140 °F), with Output Power Derating (†)  
Type of Enclosure: NEMA 4X  
DC Ground Fault Detector/Interrupter is Provided  
(†): For More Details Refer to the Instructions Manual  
(‡): For each of the two input channels  
(†): Adjustable from 57.0 Hz to 59.8 Hz  
(‡): Adjustable from 60.2 Hz to 63.0 Hz

This device complies with Part 15 of the FCC Rules. Operation is subject to the following two conditions: (1) this device may not cause harmful interference, and (2) this device must accept any interference received, including interference that may cause undesired operation.

Figure 1-1: Sample nameplate for PVI-5000-OUTD-US

## 1.4.2 PRODUCT LABEL

The product label shown below is affixed to the inverter and provides the following information:

- 1) Manufacturer code
- 2) Model code
- 3) Serial number
- 4) Week/Year of production

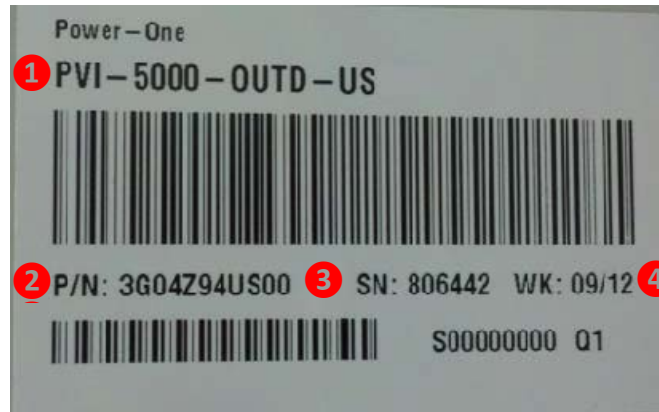

Figure 1-2: Sample product label



The labels attached to the equipment must **NOT** be removed, damaged, stained, etc. They are not to be hidden with external objects or parts such as rags, boxes, or other such equipment. They should be cleaned periodically and always maintained in view.

## 1.4.3 CONDITIONS OF WARRANTY

Warranty conditions are described in a certificate supplied with the equipment. The warranty is understood to be valid if the user observes what is described in this manual. Any conditions deviating from those described must be explicitly agreed upon in writing.

After inspecting the TRIO Inverter, fill out the warranty information and submit it to Power-One. Submitting this information will register the unit with the manufacturer and the owner will receive technical updates.

Warranty exclusions can be found on the Power-One Renewable Energy website in the download section of the AURORA TRIO product page.

# PART 2 UNPACK AND SELECT INSTALLATION LOCATION

## 2.1 TRANSPORTATION AND HANDLING

Transportation of the equipment, especially by road, must be carried out by suitable ways and means for protecting the components (in particular, the electronic components) from violent shocks, humidity, vibration, etc. During handling, do not make any sudden or fast movements that can create dangerous swinging.

### 2.1.1 LIFTING

Power-One packages and protects individual components using suitable means to make their transport and subsequent handling easier. Due to the weight and complexity of this equipment, Power-One recommends the process of loading and unloading of this equipment be done by an experienced or specialized staff knowledgeable in material handling.

The inverter weight is about 60lbs/27kg and is susceptible to tipping. It requires two or more persons to mount to bracket. Use proper lifting techniques to avoid personal injury.

Where indicated or where there is a provision, eyebolts or handles can be inserted and used as lifting points. Do not lift several units or parts of the equipment at the same time, unless otherwise indicated.

### 2.1.2 INCOMING INSPECTION

It is the customer's responsibility to examine the condition of the unit shipped. Upon receipt of Power-One's AURORA UNO Inverter, please perform the following check:

- Inspect the shipping container for any external damage.
- Inventory the contents against the listing of Table 2-1 and verify receipt of all items. Use care not to discard any equipment, parts, or manuals.
- Call the delivering carrier if damage or shortage is detected.
- If inspection reveals damage to the inverter, contact the supplier, or authorized distributor for a repair/return determination and instructions regarding the process.

**Table 2-1: Package Contents**

QTY	Description	QTY	Description
1	Aurora Inverter	1	Bag containing hardware:
1	Inverter Mounting plate	4	6.3 x 70 screws
1	Quick Installation Guide	4	S x 10 wall plugs
1	Certificate of Warranty	1	Red Cable AWG 10
1	CD-ROM containing: Communication Software, Technical Manual, Warranty Terms and Conditions	1	Black Cable AWG 10
		1	6 x 10mm machine screw
		5	6mm flat washer
		1	Torx 20 wrench

## 2.2 SELECT INSTALLATION LOCATION

### 2.2.1 GENERAL INSTALLATION CONDITIONS



The installation must be done by qualified installers and/or licensed electrician according to the applicable local code regulations (National Electric Code, Canadian Electric Code and other).

The installation must be carried out with the equipment disconnected from the grid (power disconnect switch open) and with the photovoltaic panels shaded or isolated.

#### 2.2.1.1 Environmental Check

- See Technical Data in Appendix, Part 7 to check the environmental parameters to be observed (degree of protection, temperature, humidity, altitude, etc.).
- Do not install inverter where it could be exposed to direct sunlight to avoid unwanted power reduction due to an increase in the internal temperature of the inverter.
- Do not install in small closed spaces where air cannot circulate freely.
- Due to acoustical noise (about 50dBA at 1 m) from the inverter, do not install in rooms where people live or where the prolonged presence of people or animals is expected.
- To avoid overheating, always make sure the flow of air around the inverter is not blocked.
- Do not install in places where gases or flammable substances may be present.

### 2.2.2 INSTALLATION POSITION

Install on a wall or strong structure capable of bearing the weight. Select a well-ventilated location sheltered from direct sun radiation.

Choose a location that allows unobstructed airflow around the inverter. Do not install in small closed rooms where air cannot circulate freely.

Install in safe place where all switch handles and controls remain easy to reach and meet height requirements of the applicable electrical code. Install at eye level so the display and status LEDs can be easily seen.

Ensure sufficient working area in front of the inverter to allow removal of the wiring box cover and easy access for servicing the inverter.

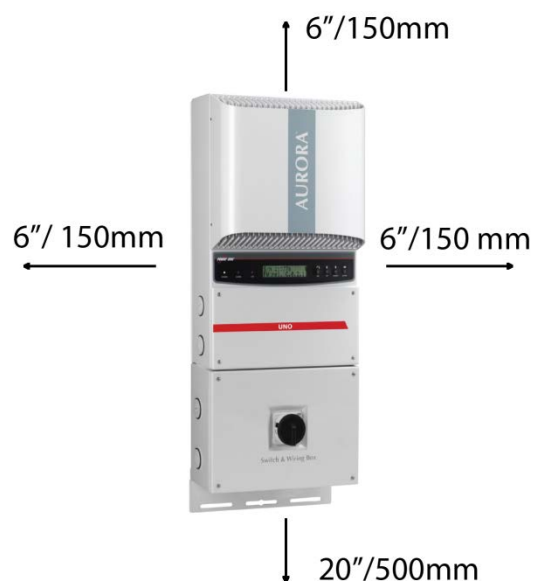

Figure 2-1: Minimum Clearances around the AURORA Inverter

For multiple-inverter installations, position the inverters side-by-side or in a staggered arrangement so heat dissipation does not affect other inverters. Maintain minimum clearances shown.

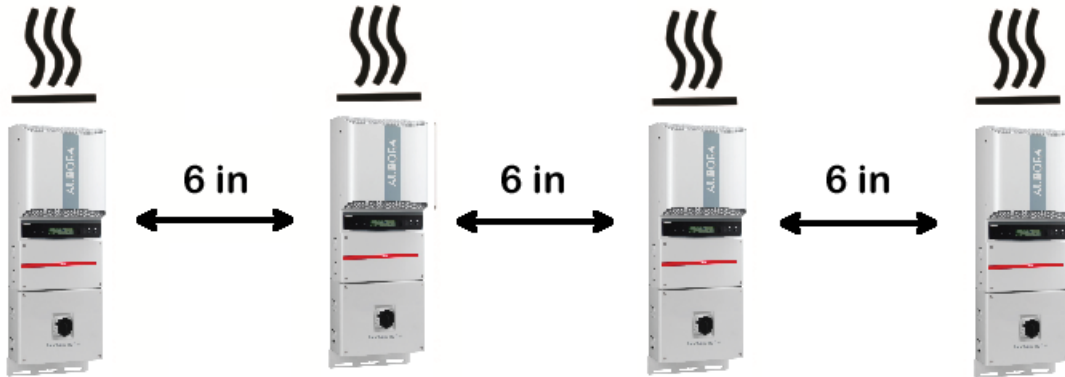
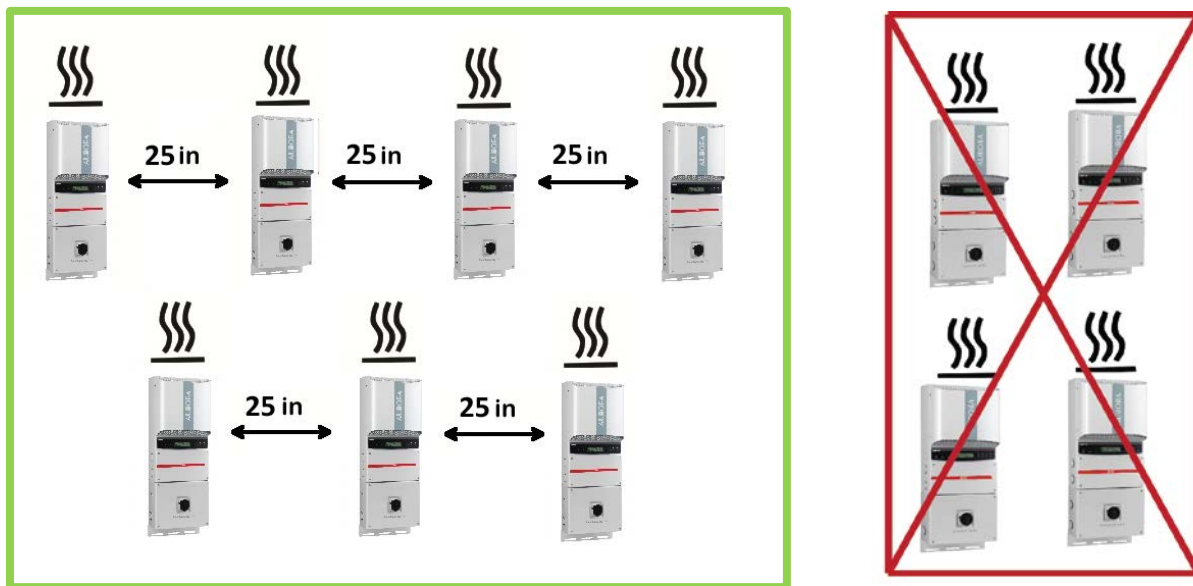

Figure 2-2: Side-by-side arrangement with minimum clearances around the AURORA Inverter



Acceptable Arrangement

Unacceptable Arrangement

Figure 2-3: Staggered arrangement avoiding heat from other inverters



Tilted mounting ( $\pm 5^\circ$  from vertical) is acceptable, but will reduce heat dissipation and may result in self-derating. When possible, mount the AURORA UNO Inverter vertically. For other mounting orientations consult with Power-One.

Do not mount the AURORA Inverter where exposed to direct sun radiation or any other heat source. This includes heat generated by other AURORA Inverters; otherwise, the inverter will self-protect, resulting in derated power output.

When the ambient temperature rises above 113°F/ 45°C the inverter may self-derate the output power. For full power of AURORA UNO Inverter (no derating), be sure the airflow through the heat sink is clear. Blockages will result in less than expected power output.

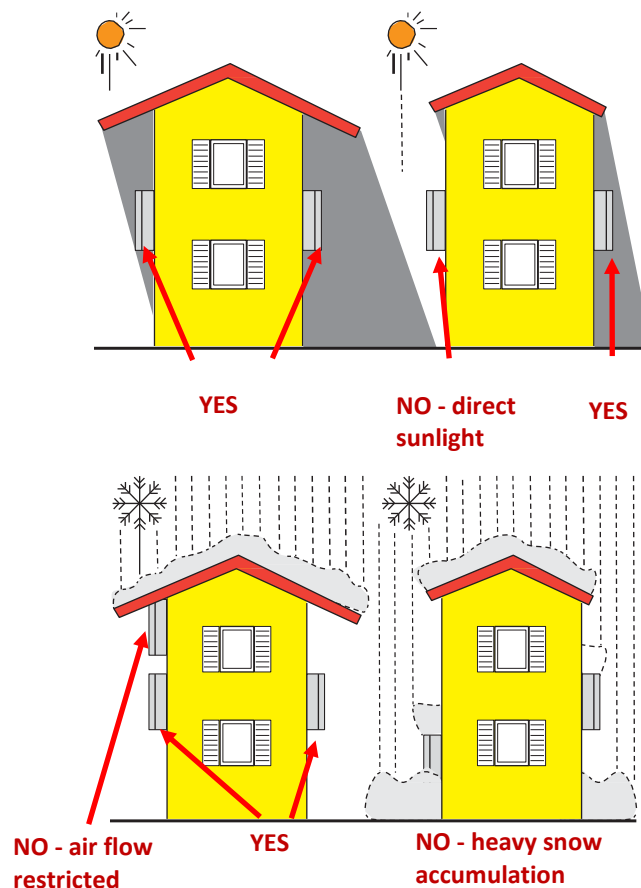

Figure 2-4: Outdoor installation examples

## PART 3 MOUNTING & WIRING

### 3.1 WALL MOUNTING

The Aurora inverter should be mounted vertically as shown in Figure 2-1 and Figure 2-4 above. Always follow the relative mounting instructions provided in this section. Follow the steps below for mounting the Aurora inverter.

Included in the shipping package is a mounting kit with four screws and four wall plugs provided for mounting the metal bracket to a concrete wall. The screws should be mounted in the four holes present in the bracket (shown as position B in Figure 3-1 below). If needed to ensure stability of the inverter, use two additional screws in the two holes shown as position A below.

**If the installation is done on a concrete wall, the wall plugs provided should be used and the mounting holes in the wall should have a 10mm diameter and 75mm depth. When the wall is made of a different material (other than concrete) the installation should be done using adequate mounting material. Power-One recommends always using stainless steel screws.**

**Step 1:** Using the mounting bracket as a template, locate and mark the desired mounting location.

**Step 2:** Using the four screws provided, level and mount the bracket to the surface using mounting holes B. Two additional screws can be used in A if necessary.

**Step 3:** Orient the bracket such that the hooks in position C face outward and upward.

**Step 4:** Hang the inverter on the mounted bracket by lifting the unit up and over the mounting plate. Guide the inverter and switchbox brackets engaging the brackets C-D and E-F on the back of the inverter.

**Step 5:** Secure chassis bottom using the machine screw and washer provided through center hole H. Engage the threaded insert in the bracket G. Add additional screws as necessary through bottom flange securing to mounting surface.

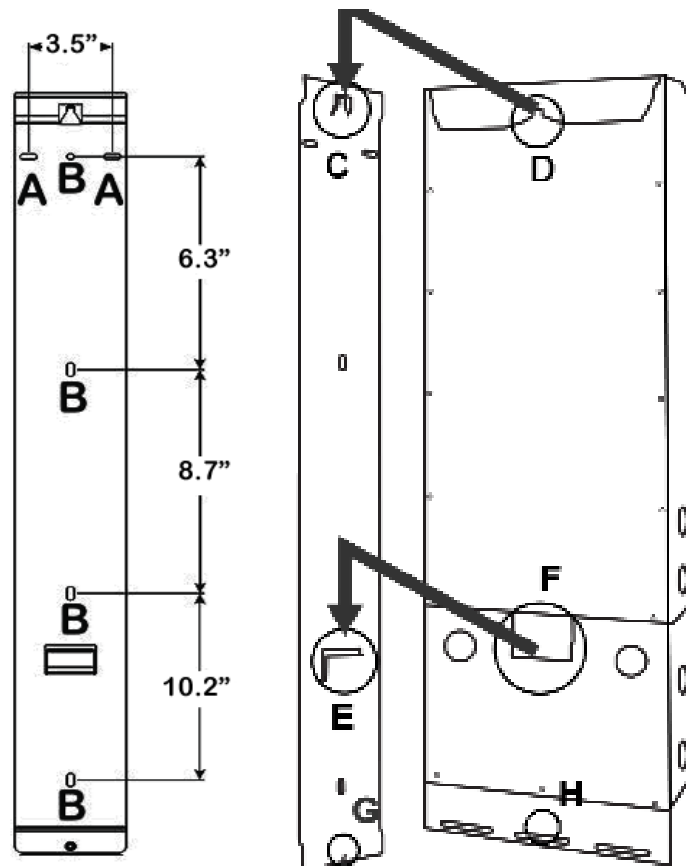

Figure 3-1: Bracket and Mounting Details



## 3.2 WIRING DETAILS

This section is dedicated to initial installation wiring of the AURORA Inverter and assumes the unit has been physically mounted in its final location, but not yet wired.



If the inverter has been previously wired and connected to the PV array and/or the AC grid, refer to Part 4: Operations for disconnection procedures.

Failure to comply with these instructions can result in safety hazards and may lead to possible injury to personnel and/or equipment damage.

### 3.2.1 CONSIDERATIONS BEFORE PERFORMING ELECTRICAL CONNECTIONS

All field wiring connected to signal circuits (WIND, ALARM, REM & RS485) should be routed inside the chassis and secured such that it cannot contact either the AC or DC wiring. It is prudent to use a UL/CSA certified cable (e.g., Belden #3106A), and it is good practice to protect the external run of this cable by means of a suitable raceway.

On the AC output side an automatic magnetothermic switch should be inserted between the Aurora inverter and the distribution grid. The models in this manual have an integrated DC switch which is rated for 25A/600V.

**WARNING:** Always respect the nominal ratings of voltage and current defined in the Appendix, (Part 7) when designing your system. Observe the following considerations in designing the photovoltaic system:



- Maximum array DC voltage input to each MPPT circuit: 600 Vdc under any condition.
- The maximum allowable input short circuit current limit of the PV array for each MPPT input channel is 22Adc.
- To reduce the risk of fire, connect only to a circuit provided with 25A, 30A, 35A for PVI-5000-OUTD-US(-A) or 30A, 35A, 40A for PVI-6000-OUTD-US(-A) maximum branch circuit overcurrent protection in accordance with the National Electric Code (ANSI/NFPA 70). See Maximum AC OCPD requirement in Appendix, Table 7-1.

### 3.2.2 REMOVING THE FRONT COVERS

To access the wiring terminals in the inverter and switchbox, the inverter cover and switchbox cover must be removed. Refer to Figure 3-2 below.

- To remove the front cover of the **inverter** compartment, loosen the four captive screws indicated using the Torx screwdriver provided.
- To remove the front cover of the **switchbox**, loosen the four captive screws indicated using the Torx screwdriver provided in the box with the inverter.
- When connection operations are completed and the unit is connected, re-install the front covers and tighten the cover screws with at least 1.5Nm (13.2 in-lbs) torque to ensure proper waterproof sealing.



Figure 3-2: Front Access Panel Location



**WARNING:** Before removing front covers, the DC switch must be in the OFF position.

### 3.2.3 AURORA SWITCH BOX DESCRIPTION

To access the wiring components inside the switchbox, loosen the four cover panel captive screws and remove the cover panel.

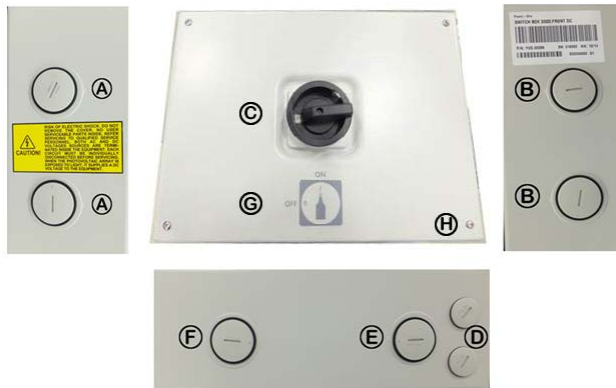

Figure 3-3: DC switchbox with front switch external chassis view



Figure 3-4: DC switchbox with bottom switch external chassis view

Table 3-1: Switchbox External Parts Summary

Label	Description	Label	Description
A	DC power cable KO's; trade size 1", 1-1/4"	E	AC power cable opening with plastic threaded plug; trade size 1", 1-1/4"
B	AC power cable KOs; trade size 1", 1-1/4"	F	DC power cable opening with plastic threaded plug; trade size 1", 1-1/4"
C	DC Disconnect Switch	G	Silkscreen ON/OFF legend
D	Signal cable opening with plastic threaded plug, 1/2" trade size	H	Cover screws (4)

The DC disconnect switch disconnects the DC PV panel current from the photovoltaic panels when the switch is in "OFF" position. The inverter will stop producing power, but it **DOES NOT** disconnect the AC from the grid.



To disconnect the inverter from the AC grid, an AC switch (not included in this AURORA Inverter's switchbox) must be disconnected.

It is the responsibility of the installer to provide external disconnect switches and Overcurrent Protection Devices (OCPD) as required by National Electric Codes and other prevailing regulations.

The DC switch is a four-pole device rated at 25A/contact. If operating in the parallel mode, feed both sets of input terminals to ensure the total input current is divided between the two sets of switch contacts to guarantee the switch current specifications are not exceeded.

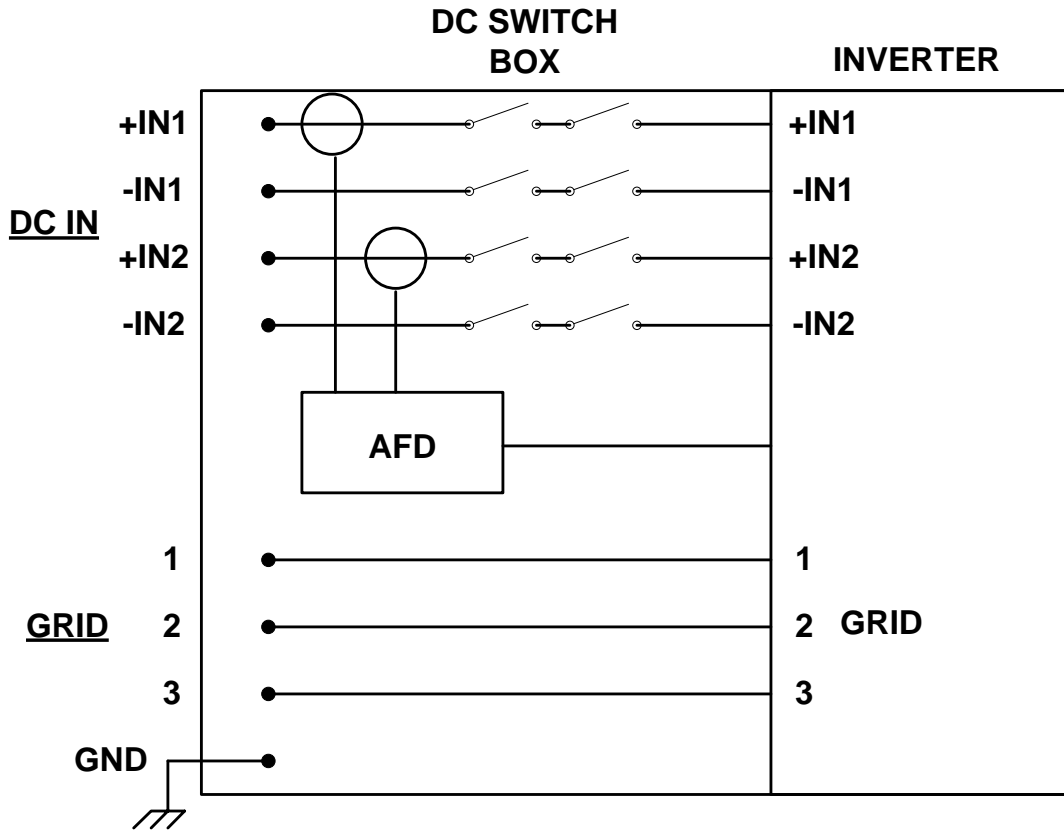

Figure 3-5: Switch Box DC Electrical Schematics - \*AFD available on -A models only

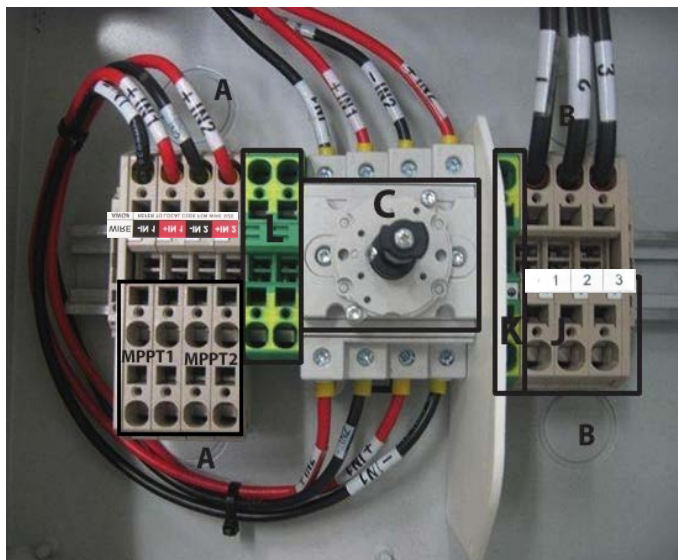

Figure 3-6: Front switch – wiring box details

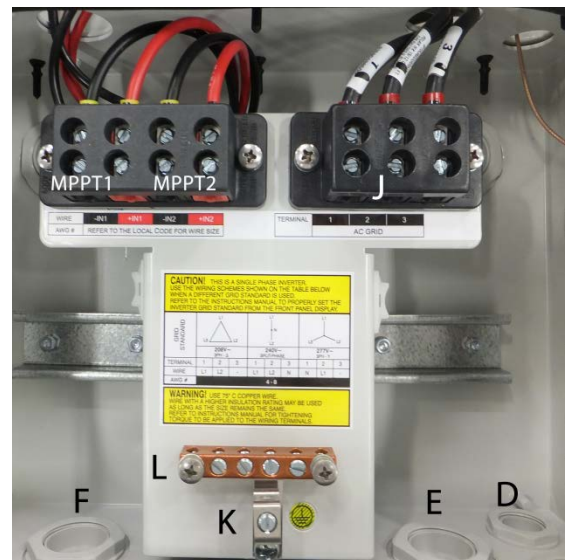

Figure 3-7: Bottom switch – wiring box details

The -A versions include an Arc Fault Detector (AFD) mounted on the rail in the wiring box.

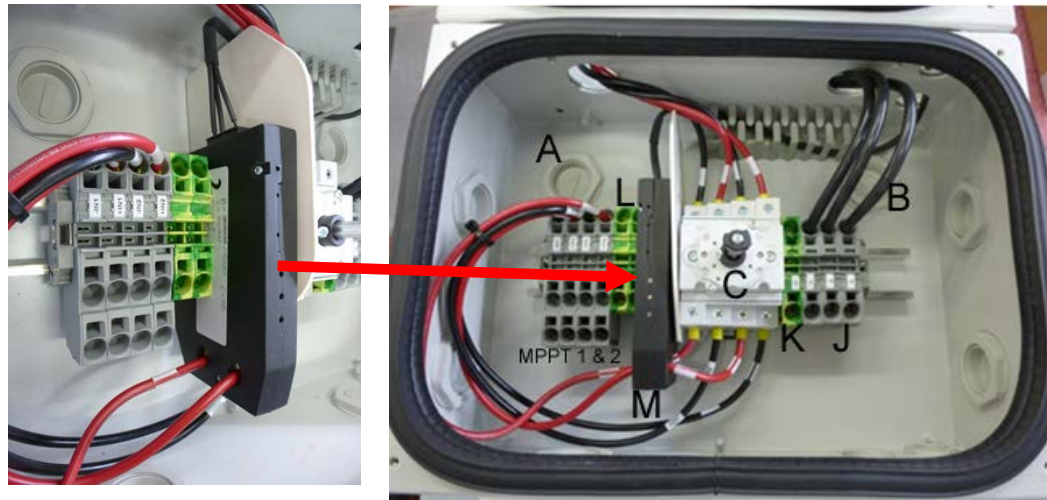

Figure 3-8: Front switch – wiring box details with AFD

Table 3-2: Switchbox Internal Parts Summary

Label	Details	Label	Details
A	DC conduit entry KOs, ¾" and 1" trade size	F	DC power cable opening with plastic threaded plug; trade size ¾" / 1"
B	AC conduit entry KOs, trade size ¾", 1"	J	AC grid output terminals, Note 1
C	DC Disconnect Switch	K	AC main ground (⊕), Note 2
D	Signal cable opening with plastic threaded plug, ½": trade size	L	Array PE ground, Note 1
E	AC power cable opening with plastic threaded plug; trade size 1"	M	AFD board (-A models only), Note 3
MPPT1	DC Array MPPT 1 input, Note 1	MPPT2	DC Array MPPT 2 input, Note 1

**Notes:**

1. Front switch model array wiring and ground terminals are spring pressure type. Use tool provided to open the terminal and insert wire. These terminals accept 16-6 AWG wire. Front switch model AC output terminals are spring pressure type. Use tool provided to open the terminal and insert wire. These terminals accept 14-4 AWG wire. Bottom switch model array wiring and AC output terminals use a standard terminal block. The wire range accepted is 18-4 AWG wire. There is a copper ground bus bar provided which accepts 14-6 AWG wire.
2. Ground terminals for the front switch model are spring pressure type and accept 16-4 AWG wire. Use tool provided to open the terminal and insert wire. Bottom switch model has two ground connections. One copper bus bar that accepts 14-6 AWG wire .
3. All wiring instructions for -A models are same as those given for -S although AFD board (M) may not be shown

Table 3-3: Bottom switch torque values for terminal bloc and ground lug

Model PVI-4.2(3.6, 3.0)-OUTD-S-US	Wire Size AWG	Temp C	Torque Nm/In-lbs	
AC and GND field wiring terminals	4-8	90	2.26	20
DC field wiring terminals	4-8	90	2.26	20
Grounding Electrode	4-8	90	5.08	45

### 3.2.1 INVERTER CONNECTION BOARD

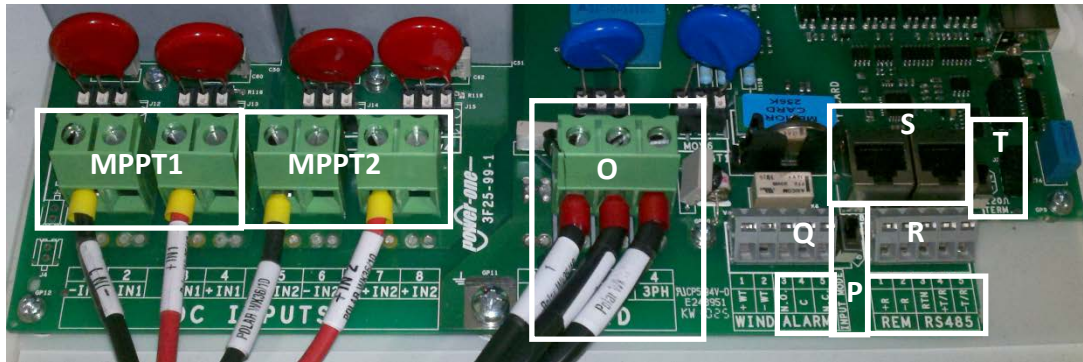

Figure 3-9: Main Inverter Connection Board

Label	Details	Label	Details
MPPT1	DC Array: MPPT 1 input , Note 1	Q	External Alarm Out Terminals, Note 4
MPPT2	DC Array: MPPT2 input, Note 1	R	RS485 Bus Connection Via Terminals, Note 4
O	AC Grid Output Terminals, Note 2	S	RS485 Bus Connection Via RJ45 Connector
P	In Mode Input Selector Switch S1 IND or PAR MPPT Operation	T	RS485 Termination Switch S2

**Notes:**

1. Terminals accept wire range up to #6AWG (Refer to local code for appropriate wire size); torque to 13in-lb.
2. Terminals accept wire range up to #4AWG (Refer to local code for appropriate wire size); torque to 13in-lb.



### 3.3 ELECTRICAL CONNECTIONS

All PV source and output circuit conductors must have disconnects and over-current protection devices (OCPD) complying with NEC, Section 690, Part III and Section 690.9.



The PV source conductors must be Listed PV wire per NEC 690.35. PV output conductors must consist of sheathed (jacketed) multi-conductor cables or installed in an approved raceway and must be isolated from the enclosure and system grounding, as required by NEC 690.35 and is the responsibility of the installer.

The maximum allowable input short circuit current limit of the photovoltaic array for each MPPT input channel is 22 Adc.



To prevent electrocution hazards, all the connection operations must be carried out with the external AC disconnect switch downstream of the inverter (grid side) open and locked out.

This section describes initial installation procedures for DC and AC wiring connections. This version has an integral DC disconnect switch and associated switchbox.

- Typical system connection for this inverter is shown in Figure 3-10.
- Relevant wiring connections are shown above in section 0.
- Refer to Figure 3-3 and Figure 3-4 to locate the designated entry locations for the conduits from the DC array and to the AC grid. Make sure the appropriate knockouts are used in order to maintain required spacing between wiring groups.

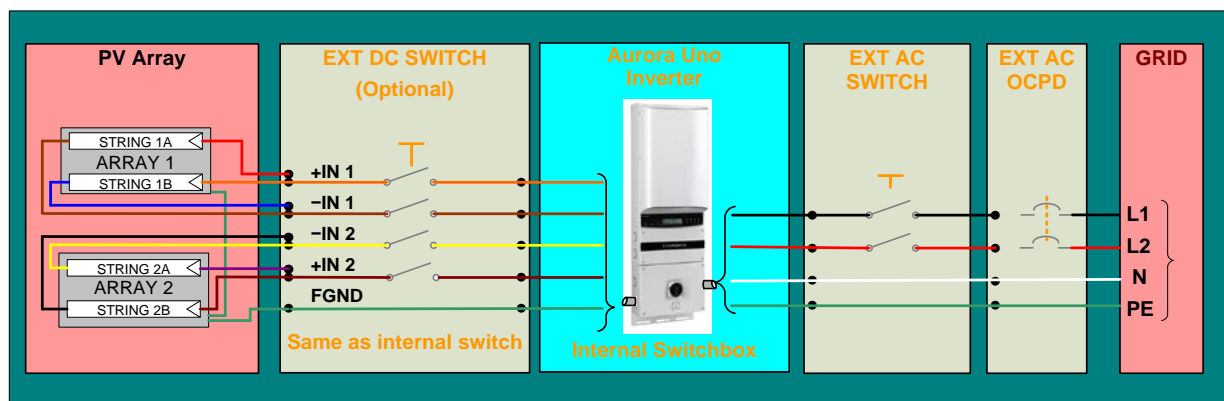

Figure 3-10: Electrical connection diagram

**WARNING:** Verify that the DC voltage in the Switchbox has the correct polarity and is within the operational range.



The array equipment grounding shall be installed per the requirements of the National Electric Code and it is responsibility of the installer.

### 3.3.1 DC ARRAY CONNECTIONS



To eliminate the potential for shock hazard during the connection procedure for the PV array wiring, either open-circuit all PV circuits prior to entry to the inverter and/or cover all panels with dark or opaque material in order to eliminate hazardous voltage at the terminals of the array wiring.

Connect array to String 1 and String 2 input positions shown below, running separate wires for POS and NEG for each array.

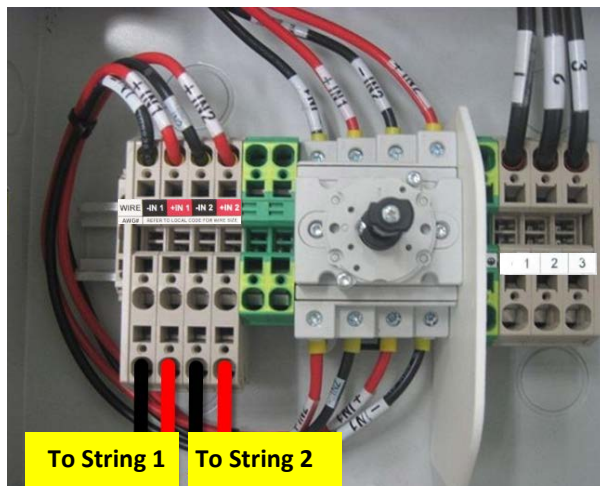

Figure 3-11: Front switch Independent configuration

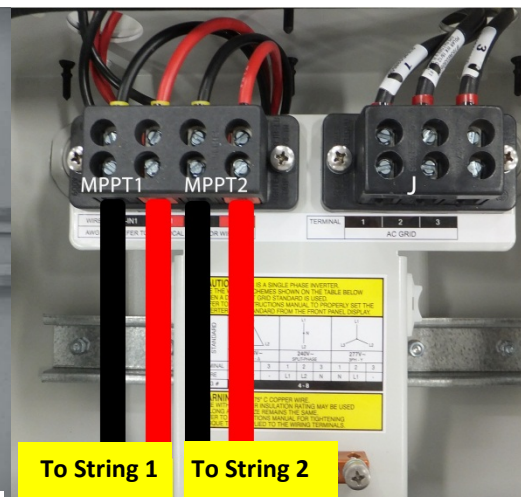

Figure 3-12: Bottom switch Independent configuration

The Aurora inverter can be configured with an independent MPPT (maximum power point tracking) for each DC input channel or with the two input DC channels connected in parallel (operating with one MPPT).

#### 3.3.1.1 Independent or Parallel Configuration of Dual Inputs

The AURORA Inverters have dual inputs with independent maximum power point tracking (MPPT) control. When operated in the dual input mode, the inverter can optimize two independent arrays. Each of the inputs is dedicated to a separate array with independent maximum power point tracking (MPPT) control. This means that the two arrays can be installed with different positions and orientation. Each array is controlled by an independent MPPT control circuit.

The two trackers can also be configured in parallel to handle power and/or current levels higher than those a single tracker can handle. The S1 switch located on the inverter connection board (Figure 3-9) is used to select the parallel or independent input mode. Switch S1 is set to independent mode as default.

The following section details how to connect the inverter in parallel mode.



### 3.3.1.2 Independent Connection (default)

The default position of the S1 switch is set in the IND mode (DOWN position).

In this mode up to four strings can be connected (two per input) without need of external combiner fusing.

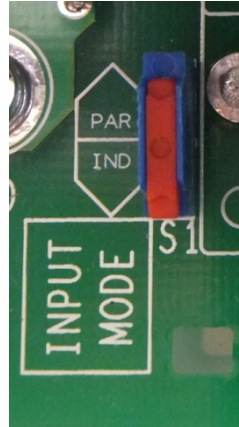

Figure 3-13: S1 Switch in IND position (independent mode)

### 3.3.1.3 Parallel Connection

It is necessary to parallel the two inputs when:

- the current from the photovoltaic array exceeds 22Adc,
- or the array power exceeds the limit for the single channel (see Appendix Table 7-1: Technical Data ),
- or when there is a consistent unbalance of power between two arrays.

To operate the inverter in the parallel MPPT mode place S1 switch UP in the PAR position.

Note that only two strings can be directly connected to the inverter in this mode. If more than two strings are required, all strings must be combined in an external fused combiner box, or the IND mode must be used.



Figure 3-14: S1 Switch in PAR position (parallel mode)

**Front switch wiring box - parallel configuration –S versions only**

In the switchbox, parallel the two MPPT inputs of terminal [–IN1 and –IN2] and [+IN1 and +IN2] as shown in Figure 3-15 using the two #10 AWG jumper wires provided (1 black and 1 red cable) to connect the input.

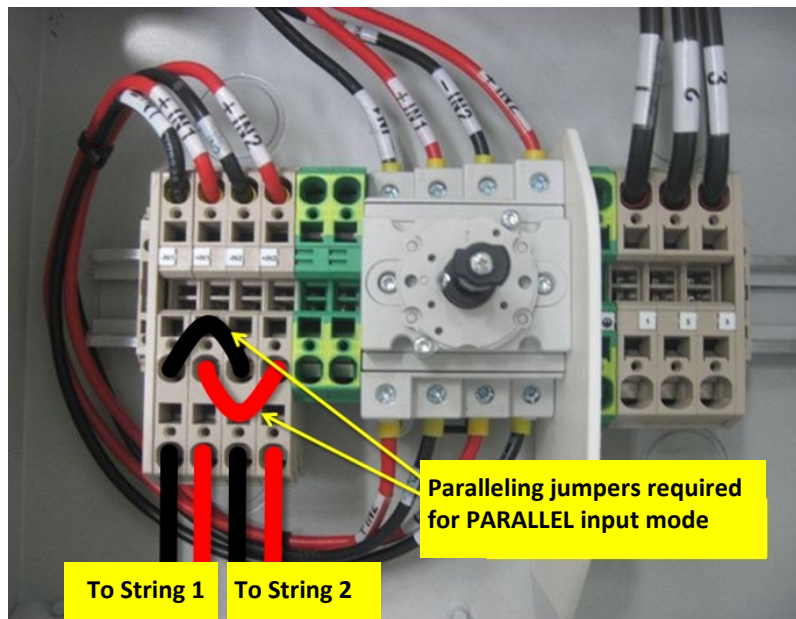

Figure 3-15: Front switch jumpers parallel MPPT input configuration –S versions only



When Arc Fault Detection (AFD) is installed, the paralleling must be done inside the inverter (Figure 3-16).

**Bottom switch wiring box - parallel configuration and Front switch –A versions only**

In the inverter box, parallel the two MPPT inputs of terminal [–IN1 and –IN2] and [+IN1 and +IN2] as shown in Figure 3-16, using the two #10 AWG jumper wires provided (one black and one red cable) to connect the input.

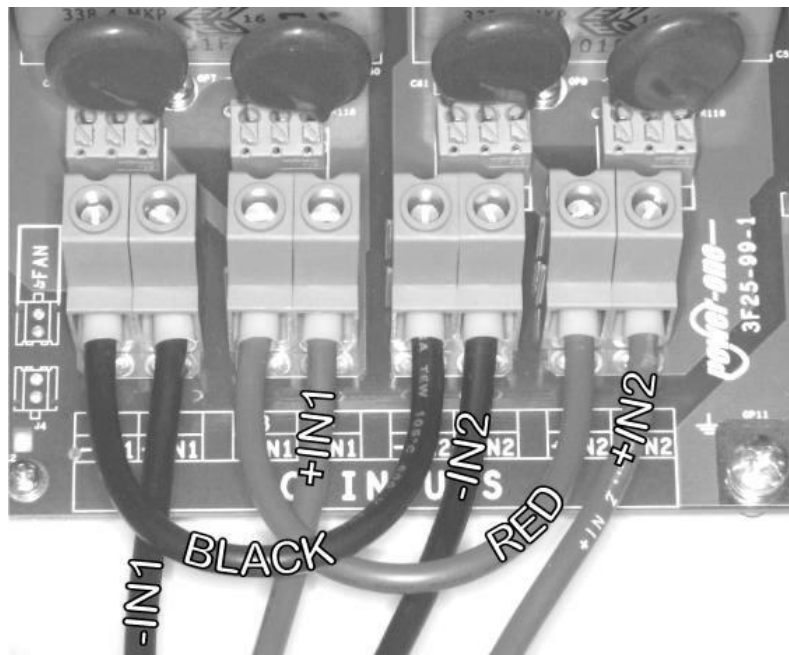

Figure 3-16: Bottom switch jumpers for parallel MPPT Configuration and Front switch –A versions only

### 3.3.2 AC GRID CONNECTIONS



AC output overcurrent protection is not provided with the Aurora; it is the responsibility of the end user to provide overcurrent protection for the AC output circuit.

AC grid wiring is connected through the inverter switchbox. Run an approved raceway between inverter and external AC disconnect switch. Make conduit entry through openings (B or E) shown in Figure 3-3 and Figure 3-4.

Connect AC wiring to switch box terminal block (J) and the main AC ground cable to switchbox terminal block (K).

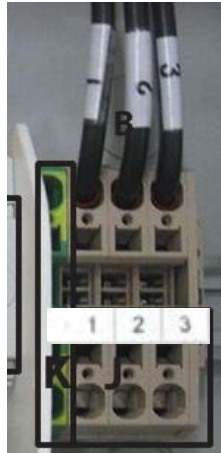

Figure 3-17: Front switch AC Grid terminal



Figure 3-18: Bottom switch AC grid terminal

Table 3-4, which is also on a label within the switch box, shows AC wiring connections according to the AC grid type; connect wiring to the numbered terminals as shown. **Size conductors per NEC Article 310; use only 75°C or 90°C. copper wire only. Terminal block accommodates conductor type shown and wire size range per Table 3-2 and Table 3-3.**

Table 3-4: AC Grid Standard

GRID STANDARD									
	208V~ 3PH – Δ – 3W			240V~ SPLIT-PHASE			277V~ 3PH – Y		
TERMINAL	1	2	3	1	2	3	1	2	3
WIRE	L1*	L2*	-	L1	L2	N	N	L1*	-

(\*) **IMPORTANT:** If several Aurora inverters are installed to a three-phase AC GRID, always distribute the inverters between the phases in order to reduce power imbalance between the phases. Always refer to the local standards.

The default AC grid connection, 240V<sub>RMS</sub>/3W/Split-Phase, requires the Neutral terminal to be connected to the grid neutral conductor for proper operation.



Before connecting the inverter to the grid the grid type must be selected if it differs from the default 240V-SPLIT PHASE setting. See Operations, section 4.2.5.2 - Set Vgrid, for instructions to change the default.

### 3.3.3 SIGNAL WIRING CONNECTIONS

The AURORA Inverters have remote monitoring and capabilities which are accessed externally using an RS485 communication port. The AURORA Inverter is provisioned with the communication capability as a standard feature, and all that is needed for remote monitoring is monitoring hardware which connects to the RS485 port and collects the available data.

#### 3.3.3.1 Connection of RS485 and Alarm Contact

Route the cables through the switchbox and into the inverter keeping close to right wall of the switchbox chassis.

- For versions with a front-facing switch, route the cables through the plastic guides located on the side of the wiring box.
- For versions with a bottom switch, use the plastic clamp to secure to the wall.



Front switch – cable guides

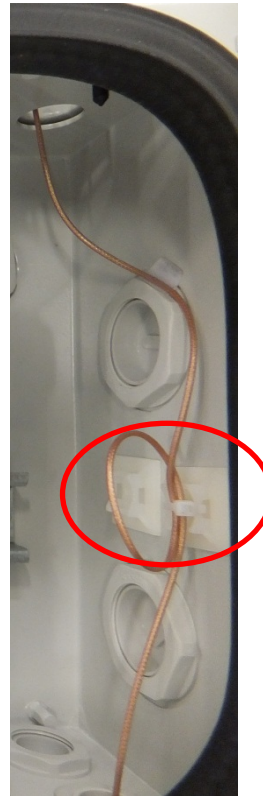

Bottom switch – cable clamp

Refer to Figure 3-19. Locate the terminals for the alarm and monitoring connections within the inverter. The following sections provide detail of the RS-485 wiring connections.

### 3.3.3.2 Alarm contact connection

Three connections are provided to drive an external alarm comprised of a common contact, a normally open contact and a normally closed contact. To cable the alarm contact, use a three-wire or two-wire cable.

### 3.3.3.3 Connection of RS485 Serial Port

Inside the inverter the communication line cabling can be done using the RJ45 connectors or using the terminal block (Figure 3-19). If the terminal blocks are used, the signal RTN, +T/R and -T/R have to be cabled. If the RJ45 plugs are used, the pin-out is reported in Table 3- 1 below.

Table 3- 1: RJ45 Connectors

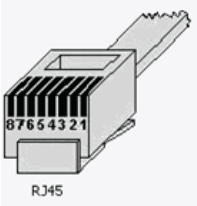
	Pin #	Signal Name	Description	Notes
	1,2,6,8	N/U	Not Used	-
	3	+TR	+ Data Line	1
	4	+R	DO NOT CONNECT	2
	5	-TR	- Data Line	1
	7	RTN	Signal Return	1

1. Required for RS485 communication.  
2. Required for Remote OFF control; **DO NOT CONNECT pin #4** when cabling units with AFD installed.

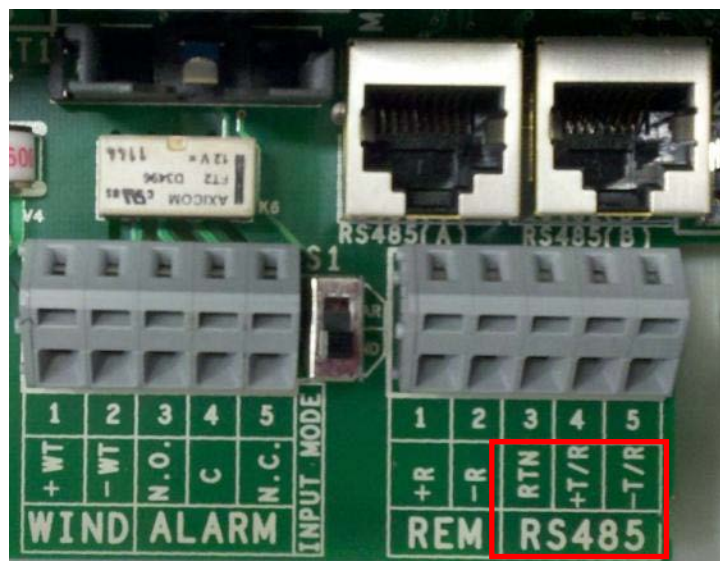

Figure 3-19: Standard RS485 connection



**CAUTION HAZARDOUS VOLTAGE** – The  $\pm$ WT (WIND) terminals are not isolated and can have hazardous voltages present. These terminals must not be utilized for any purpose in a PV installation (for use with wind models only).



Use a cable designed for use with RS-485 communications such as Belden 3106A, which is a data cable wire with one twisted pair, one ground conductor, and a shield with drain wire (equivalent). The shield wiring must be continuous as it passes from one inverter to the next on a daisy chain, but must not be tied to ground at these junctions.

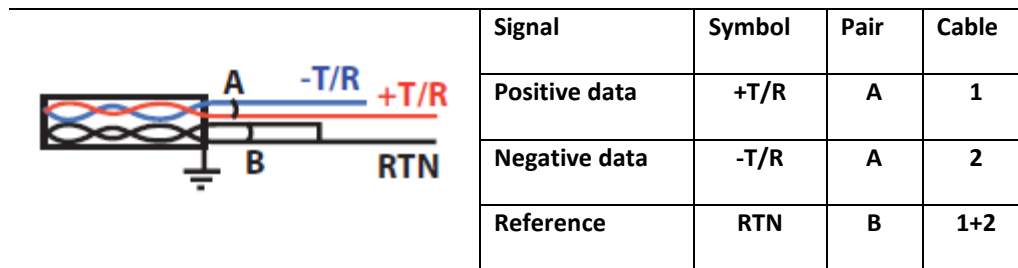

Figure 3-20: Data cable for use with RS-485 communications



**Continuity of the shield in the RS-485 cable is important for low noise on the line; this is particularly so for large plants with multiple inverters. For best results the shield must be tied to ground at only one point on the line, typically at one end or the other.**

The shield wiring must be continuous as it passes from one inverter to the next on a daisy chain, but must not be tied to ground at these junctions.

The SH terminal is provided as a floating tie point for this purpose. It allows shields (drain wires) from incoming and out-going daisy chain cables to be secured together but not grounded.

If using standard multi-conductor RS-485 cable, connect the three RS-485 leads (-RTN, +T/R, -T/R) to the terminal block corresponding points (Figure 3-19).

### 3.3.4 DAISY CHAIN MULTI-UNIT CONFIGURATION

The RS-485 terminal block or RJ45 connectors are used in a multi-unit daisy-chain.



**If a daisy chain connection is required for AFD installed inverters use standard multiconductor RS-485 cable and connect the three RS-485 leads (-RTN, +T/R, -T/R) using only the mating connector in Figure 3-13. Do not connect pin 4 of RJ45 connector in any case with AFD installed inverters.**

#### 3.3.4.1 Connection & Cabling

Per the RS-485 standard, it is possible to connect up to 31 AURORA Inverters on one RS-485 bus link; however, the feasibility of this arrangement is dependent on the type of cabling used for the link and the workmanship of the bus connections. Also, most data loggers are limited by the manufacturer as to the total number of slave units connectable. Please verify all aspects of the intended communication system and components before attempting to install a monitoring system.

The recommended length of total communication cable line for all inverters in the system is 1,000 meters [1094 yards] or less, and this distance capability depends strongly on the cable type used and installation workmanship.

Depending on the type of computer used, the cable line adaptor can be RS-485-RS232 or RS-485 to USB. In order to ensure optimum communication on the RS-485 line, Power-One recommends connecting the RS-485 converter to a location between the first unit in the daisy chain or multi-unit system configuration and the computer; not in between two inverters in the series.

Using the appropriate cable, connect all the Aurora Inverter units. RS-485 lines in a series according to the daisy chain method.

On the last inverter in a daisy chain, or on a single inverter, activate the termination resistance of the communication line by moving switch S2 down into the ON position. All other inverters in the daisy chain will have the switch S2 up in the OFF position (Figure 3-22).

**NOTE:**

- The **ON** position means the RS485 port is inactive.
- The **OFF** position means the RS485 port is active.

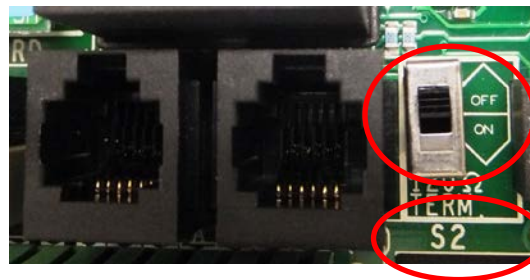

Figure 3-21: Termination Switch S2

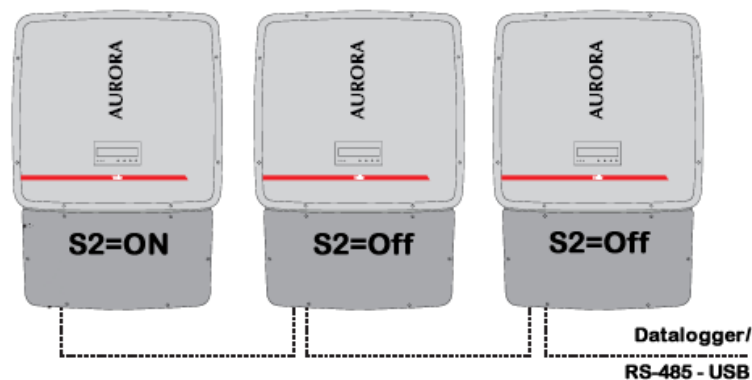

Figure 3-22: Daisy Chain Communication Wiring

### 3.3.4.2 Addressing Each Inverter

When multiple inverters are connected in a daisy chain, it is necessary to assign a different RS-485 address to each unit.

This enables the bus addresses (for the inverter connected to the RS-485 communication bus) to be set to an appropriate value. Address values are assigned manually using any value in the range [2 to 64]. See Part 4, section 4.2.5.2 for instructions to assign addresses using the display menu.

Other third party RS-485 converters available on the market can also be used, but Power-One does not assure correct connection operation since these devices have never been specifically tested. Also, please note that other commercial devices could require external termination impedance, which is not necessary for Aurora brand RS-485 converters.

# PART 4 OPERATIONS GUIDE

## 4.1 MONITORING AND DATA TRANSMISSION



In order to prevent damage to the equipment and injury to the operator IT is essential to have a thorough knowledge of the user interface.

**Power-One** cannot be held responsible for damage to the equipment or the operator if caused by incompetence, insufficient qualifications or lack of training.

### 4.1.1 USER INTERFACE

The AURORA Inverter provides operational data to the user through the following instruments:

- LED Indicator lights
- Liquid Crystal Display (LCD)
- Digital data transmission via a dedicated RS-485 serial port using **AURORA Inverter Protocol** and a PC or a data logger equipped with an RS-485 port to collect data.

If an RS-485 line is used, it may be convenient to use the AURORA USB/RS-485\_232 serial interface converter (model number PVI-USB-RS485\_232). The optional AURORA PVI-UNIVERSAL data logger is also available, which allows a web-based monitoring platform.

- Data transmission via USB cable. This type of connection is typically used when monitoring a single inverter and for maintenance purposes. To connect the USB cable, remove the waterproof plug at the bottom end of the inverter right wall to access the USB input.

### Monitoring System Options

#### Simple Monitor

- Aurora RS485/USB Line Converter
- User Supplied PC
- Use **Aurora Communicator** Software

#### Web Based Data Logger

- Use **Aurora Universal** Data Logger
- Optional I/O (Meters, Irradiance Sensors, etc.) can be connected
- Ethernet (LAN) to Internet and connection to Aurora Web Portal service

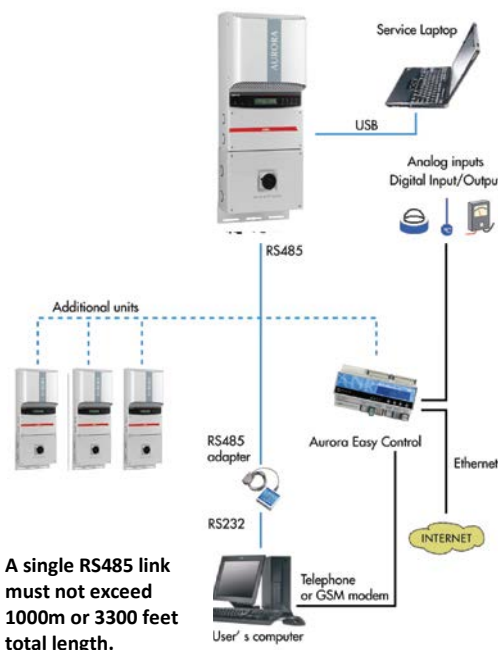

Figure 4-1: Data Transmission Options



## 4.1.2 DATA TYPES AVAILABLE

AURORA Inverter provides two types of data that can be collected using the display and/or the appropriate interface software.

### 4.1.2.1 *Real-Time Operational Data*

Real-time operational data can be transmitted on demand through the communication lines and are not stored inside the inverter. The free AURORA Communicator software (included on the installation CD) may be used to transmit data to a PC. Please check the Power-One website at [www.power-one.com](http://www.power-one.com) for the latest updated version.

The following data is available via the RS-485 link:

- Grid voltage
- Grid current
- Grid frequency
- Power transferred to the grid
- Voltage of photovoltaic array 1
- Current of photovoltaic array 1
- Voltage of photovoltaic array 2
- Current of photovoltaic array 2
- Serial Number/Code
- Week of production
- Firmware revision code
- Daily energy
- Leakage current of the system
- Total energy
- Partial energy
- Mean grid voltage
- Insulation resistance
- Leakage current to ground
- Date, time

### 4.1.2.2 *Data Logged Internally*

Power-One's AURORA Vision stores the following data internally:

- Total and partial counter of grid connection time.
- Total and partial counter of energy transferred to the grid.
- Daily Energy Production (365 values).
- Energy transferred to the grid every 10 seconds for the last 8,640 periods of 10 seconds (which on average cover more than 2 days of logged data).
- Last 100 fault conditions with error code and time stamp.
- Last 100 changes to grid connection parameters with parameter code and new value.

The first two types of data (Total and partial counters) are displayed on the LCD and through the RS-485 interface, while all other data logged internally can be displayed only through the RS-485 interface.

### 4.1.3 DISPLAY AND KEYPAD

AURORA Inverters are equipped with an LCD, four buttons for menu navigation and three LEDs indicating the device status.

- **POWER** LED (green) indicates the AURORA Inverter is operating normally. This light flashes upon start-up, during the grid check routine. If a correct grid voltage is detected and sunlight is strong enough to start-up the unit, the LED stays on steady. If not, the LED keeps flashing until sunlight becomes strong enough to start-up the inverter. In this condition, the display will read '**Waiting Sun....**'
- **ALARM** LED (yellow) indicates a fault condition has been detected. A description will appear in the two-line display.
- **GFI** LED (red) indicates the inverter has detected a ground fault in the DC side of the PV system. When this kind of fault is detected, the AURORA Inverter disconnects from the grid and the corresponding fault indication appears in the two-line LCD display.

The AURORA Inverter remains in this condition until the operator presses the **ESC** key to re-start the grid connection sequence. If pressing the **ESC** key doesn't clear the ground fault, check the ground-fault fuse located in the switchbox. If the AURORA Inverter does not reconnect to the grid, contact Power-One Technical Service.

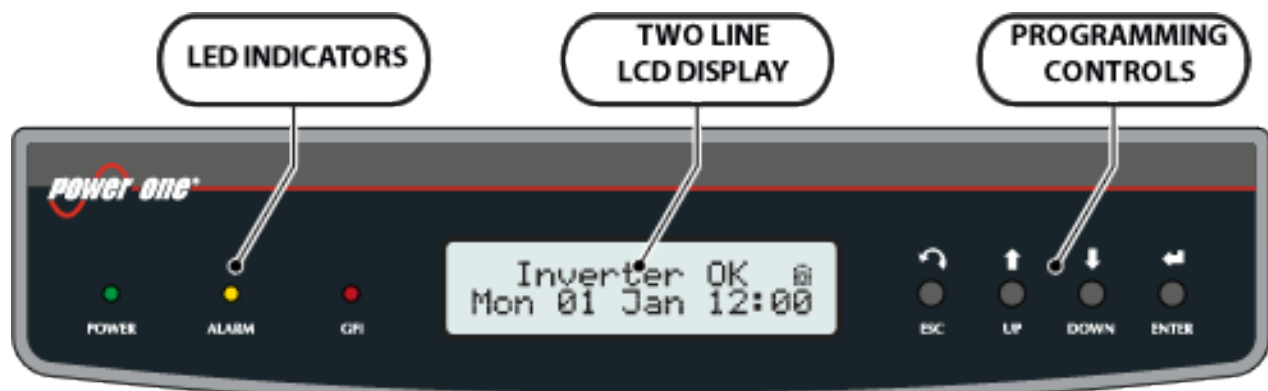

Figure 4-2: LED Indicators and Controls

A two-line LCD located in the center of the front panel provides Inverter operating status and statistics, Service messages for the operator, and Alarm and fault indicators

During operation, the display cycles through available data points, updating every five seconds. Screens may be scrolled manually by pressing the **UP** and **DOWN** Programming Control keys. Pressing the **ESC** key gives access to three main menus: **Statistics - Settings - Info**. To return to the preceding menu, press the **ESC** key







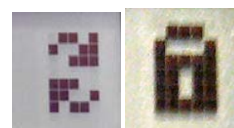



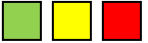
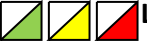

















The *Statistics*, *Settings* and *Info* menus can be accessed with just the array connected. Some parameters (e.g., current, voltage, power, partial energy, lifetime energy etc.) are available only after grid connection.

Activation of cyclical scrolling will be indicated by two arrows in the top left corner of the two-line display.

Scrolling can be blocked by pressing the **ENTER** key. A padlock symbol will appear.



In their various combinations, the LEDs can indicate conditions that are different from the single one. The following table shows the possible combinations of LED-signalling indications related to the operational status of AURORA Inverter.

LED BEHAVIOR			
 LED off	 LED on	 LED flashing	 Any condition
LED STATUS	OPERATIONAL STATE	DESCRIPTION	
1: green:  2: yellow:  3: red: 	Inverter off; AURORA self-disconnects during night	Input voltage and/or power are not sufficient to switch on the inverter.	
1: green:  2: yellow:  3: red: 	STAND-BY: Inverter initialization	Transition state during which the inverter is waiting for sufficient sunlight to start. The inverter checks the parameters necessary for connection to the grid, such as input voltage, grid voltage, etc.	
1: green:  2: yellow:  3: red: 	STAND-BY WITH WARNING: inverter initialization in presence of a fault or anomaly. Grid is disconnected.	The inverter is waiting for sufficient sunlight to start exporting energy to the grid and checks the parameters necessary for connection to the grid. However it has also detected a condition which could limit its functionality. A warning message (Wxxx code) is on the LCD.	
1: green:  2: yellow:  3: red: 	The inverter is connected to and feeding energy to the grid.	Normal operation. The inverter automatically searches for and tracks the maximum power point (MPPT) from the PV array.	
1: green:  2: yellow:  3: red: 	RUN with WARNING: The inverter is connecting and feeding power to the grid in the presence of an anomaly.	The inverter is connected to the grid and an anomaly, which may be internal or external to the inverter, has been detected. A warning message (Wxxx) is on the LCD.	
1: green  2: yellow  3: red 	W warning code E error code	Inverter detects an anomaly (Wxxx) or a fault (Exxx) in the system, which may be internal or external, and displays a message.	
1: green:  2: yellow:  3: red: 	INVERTER ALARM	A malfunction of the inverter prevents export of power to the grid. An error message (Exxx) is displayed on the LCD.	
1: green  2: yellow  3: red 	Internal Fan fault	The inverter does not disconnect and stays operational; however, critical environmental conditions may create over-temperature conditions with possible power limitations.	
1: green:  2: yellow:  3: red: 	GRID ALARM: There is a problem with the electrical grid.	Indicates the grid voltage for connection is not present. The inverter shows "Missing Grid" message on display.	

## 4.2 COMMISSIONING



**Do not place any items on the AURORA Inverter during operation.**

**Do not touch the heat sink when the inverter is operating, as some parts may be hot and cause burns.**

The procedure for commissioning AURORA Inverter is as follows:

- 1) Set the inverter's DC disconnect switch to ON.
- 2) Set the AC disconnect switch to the inverter to ON.

**NOTE: There is no specific order for closing the two switches.**

- 3) Once both disconnects are closed, the inverter starts the grid connection sequence. This routine is indicated by the flashing green LED labeled POWER on the display.

This routine may take from 30 seconds up to several minutes, depending on grid condition. Three messages are displayed in sequence on the LCD during this routine:

- “Measuring Riso...” connection in progress with progress signal (Riso = insulating resistance).
  - Grid voltage value and status compared to specified values (within/outside range).
  - Grid frequency value and status compared to specified values (within/outside range).
- 4) When the connection sequence is completed the AURORA Inverter starts operating. Proper operation is indicated by a warning sound and the steady green LED lights. This means the sunlight is sufficient to feed the grid.
  - 5) If the grid check routine does not give a positive result, the unit will repeat the procedure until all grid voltage, frequency parameters, and grid configuration are found (or changed) to be within the specified range. During this process, the green LED will keep flashing.

### 4.2.1 CONNECTION OF THE SYSTEM TO THE GRID

The following two screens are displayed at inverter start-up:

POWER-ONE

Initializing...  
Please wait

When waiting for sunlight ('Waiting Sun'), the POWER LED flashes GREEN.

Waiting Sun

While the system checks for grid connection to be established ('Missing Grid'), the ALARM LED turns steady YELLOW, while the POWER LED flashes GREEN.

Missing Grid

As soon as the 'Missing Grid' and 'Waiting Sun' conditions are met successfully, the inverter is connected and displays the following.

**For –A versions ONLY, the display shows the AFD board self-test running and results:**

If the self-test results are OK, the inverter will continue to Next connections.



**If a potential problem on the AFD board is detected, the self-test will result in error. Refer to Table 5-1 in Troubleshooting to clear the error and possible solutions.**

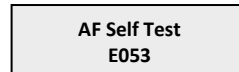

**All versions will display the following screens during connection:**

This display shows the time (seconds) remaining to complete the output voltage and frequency values check.



This display shows the instant output voltage value and whether it is within/outside range status.



This displays the instant output frequency value and whether it is within/outside range status.



If the measured instant values of voltage and frequency are outside the allowed range, the above three screens are scrolled alternately: **Next connections → Vgrid → Fgrid**

### 4.2.2 ERROR MESSAGES

After the connection is established, the inverter runs a test cycle. If the wrong data is found, the cycle is interrupted and an error code is displayed. Refer to Table 5-1 in Troubleshooting for error codes and their meanings.

Until the error is rectified, the following screens are alternately displayed:

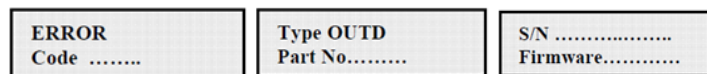

Once the error is cleared, the inverter resets all functions in progress and re-starts the connection.

### 4.2.3 FIRST PHASE- ELECTRIC PARAMETER CHECK

If the measurements taken in section 4.2.1 are found to be correct, the system will proceed to the next checks. The twelve screens outlined below are scrolled alternately on the display.

1) Inverter type and part number.

Type OUTD
PN-----

2) This display shows the inverter serial number and firmware revision level.

S/N-----	xxxxxx
FW rel.	C.0.1.1

3) E-da: Daily energy output.  
\$-da: Daily energy savings. The value is expressed in the set currency.

E-da	0 KWh
\$-da	0.0 \$

4) E-tot: Total energy output (since first installation).  
E-par : Partial energy output during the period selected by user.

E-tot	-----
E-par	0 KWh

5) P-out: Measures instant output power.  
The second line of the display shows the higher of the two temperatures:

P-out	0 W
T-boost1	- °C

- T-boost1: Booster channel 1 switching device temperature.
- T-boost2: Booster channel 2 switching device temperature.

6) Ppk: Maximum peak power achieved since the 'partial' function was activated.  
Ppk-Day: Indicates the maximum peak power achieved during the day. The counter will reset when unit is powered OFF.

Ppk	W
Ppk-Day	.....W

7) Vgrid: Measures instant grid voltage.  
Vgrid Avg: Average grid voltage during the last 10 minutes of inverter operation.

Vgrid	197 V
Vgrid Avg	0 V

8) Igrid: Measures instant grid current.  
Fgrid: Measures instant grid frequency.

Igrid	0.8 A
Fgrid	50.18 Hz

9) Vin1: Instant input voltage value measured at channel 1 input.  
Iin1: Instant input current value measured at channel 1 input.

Vin1	0 V
I in1	0.0 A

10) Vin2: Instant input voltage value measured at channel 2 input.  
Iin2: Instant input current value measured at channel 2 input.

Vin2	0 V
I in2	0.0 A

If the inverter configuration is set for single input (Parallel) mode, this screen appears instead of the two screens previously described in 9A and 10A.

Vin	0 V
I in	0.0 A

- 11) Pin1: Measures instant input power of channel 1.  
Pin2: Measures instant input power of channel 2.

Pin 1	0 W
Pin 2	0 W

If the inverter configuration is set for single input (Parallel) mode, this screen appears instead of the screen described in 11.

Pin	0 W
-----	-----

- 12) Riso: Measured insulation resistance. Unlike the parameters discussed above, this is not an instant value but a one-of-a-kind measurement taken upon inverter start-up.

Riso	0.0 Mohm
Ileak	73 mA

Ileak: Value of the leakage current passing through the grounding fuse and displayed only when the connected positive or negative terminal is being grounded

If all items described above test OK, the inverter shows a corresponding message in the display top line along with the date and time.

Inverter OK
Wed 17 May 11 23

Clock malfunctioning or other non- function-related faults (meaning faults that do not affect the inverter's ability to generate energy) are shown in the second line of the display instead of the date and time. The following error messages could be displayed:

- CLOCK FAILURE: Indicates clock malfunction; contact Technical Support.
- BATTERY LOW
- ADJ. TIME: Appears the first time the unit is powered up or after the battery has been replaced.
- FAN FAILURE: Does not affect the inverter's proper operation; replace the fan at the first convenient opportunity.
- MEMORY FAILURE: Data logging malfunction. Contact Technical Support.

#### 4.2.4 NORMAL START- UP PROCEDURE

Normally, the Aurora inverter operates automatically and needs no particular supervision. When sunlight is not enough to generate power for the grid (for instance, at night), the Aurora disconnects automatically and goes into standby mode. The operating cycle is resumed automatically when sunlight becomes strong enough. This is indicated by the LEDs on the front panel display. Depending on the DC input voltage present, the inverter behaves as follows:

- When the inverter is switched ON, it will start as soon as the input voltage value exceeds the set Vin start value.
- The inverter will display the message 'Waiting Sun' until the input voltage exceeds the set Vin start value.
- When the Vin start value is exceeded, the inverter will connect to the grid if it is identified or it will display the message 'Vac absent' if the grid is not connected.
- The inverter will remain connected to the grid if the input voltage is between 70% of the Vin start set and 480 Vdc. If the input voltage value is outside this range, the inverter disconnects itself from the grid.

### 4.3 DESCRIPTION OF THE MENUS

The three main menus enable monitoring of the inverter’s operations and are outlined below. To access the menus from the initial screen, press the **ESC** button. Use the **UP** and **DOWN** keys to scroll through the three menu and press **ENTER** to make a selection.

The Settings menu allows access to configuration and modification of the basic inverter settings. See section 4.2.7 for instructions to view and adjust the parameters.

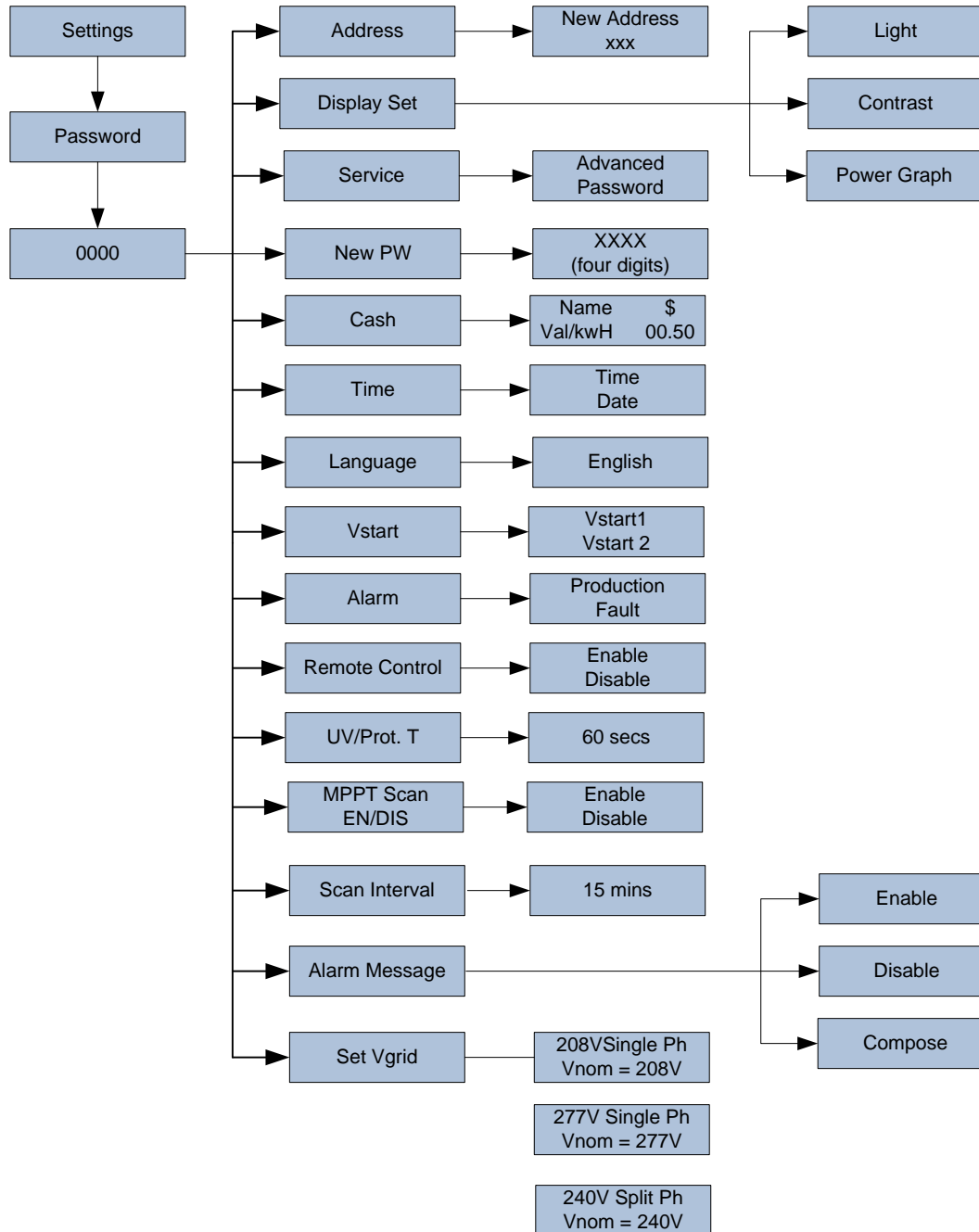





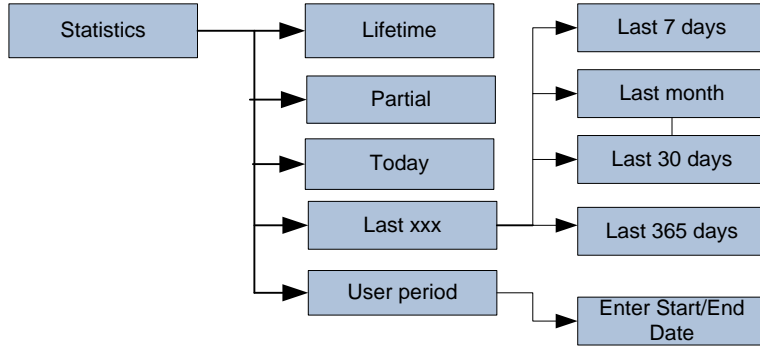

The Statistics menu is a view only display of internally logged inverter data. See section 4.2.5.1 for a description of each parameter in the submenu.

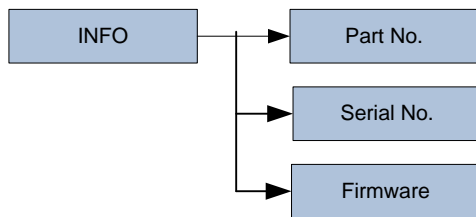

The INFO menu provides information about the inverter. A complete description of the submenus can be found in section 4.2.5.3.



**Display Key Operation using Programming Controls**

-  Press **ENTER** to open a selection or confirm an entry.
-  Press the **UP** and **DOWN** keys to move through menu items or increase/decrease numerical settings.
-  Press the **ESC** key to access the three main menus, go back to the previous menu, or go back to the previous digit to be edited.

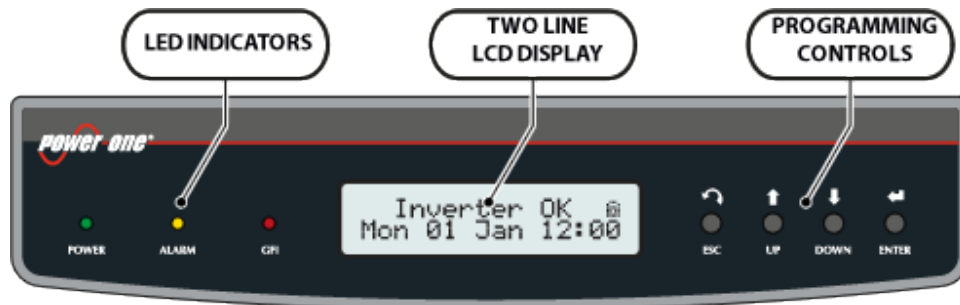

### 4.3.1 STATISTICS MENU

Press ENTER to select the **STATISTICS** menu and display the submenu.

An arrow on the left side of the display highlights the current selection.

Only two lines can be viewed on the display; use the UP and DOWN control keys to scroll through all selections. Press ENTER to open the submenu corresponding to the arrow.

⇐	Lifetime
	Partial
	Today
	Last 7 days
	Last Month
	Last 30 Days
	Last 365 Days
	User period

#### Lifetime

- Time: Lifetime operation time
- E-tot: Total energy produced
- Val. : Economic gain
- CO<sub>2</sub>: CO<sub>2</sub> saving compared to fossil fuels

Time	h
E-tot	KWh
Val.	\$
CO2	lb

#### Partial

- Time: Total operation time since the counter was last reset. \*
- E-par: Total energy produced since the counter was last reset. \*
- PPeak: Maximum peak power measured since the 'partial' counter was activated
- Val. : Economic gain since the counter was last reset.\*
- CO<sub>2</sub>: CO<sub>2</sub> saving compared to fossil fuels since counter was last reset. \*

Time	h
E-par	KWh
Ppeak	W
Val.	\$
CO2	lb

\* To reset all counters in this submenu, Press and Hold the ENTER key until a warning sound is repeated 3 times.

#### Today

- E-tod: Total energy produced during the day.
- Ppeak: Peak power value achieved during the day.
- Val. : Economic gain during the day.
- CO<sub>2</sub>: CO<sub>2</sub> saving for the day compared to fossil fuels.

E-tod	KWh
Ppeak	W
Val.	\$
CO2	lb

#### Last 7 Days

- E-7d: Total energy output over the last 7 days.
- Val. : Economic gain over the last 7 days.
- CO<sub>2</sub>: CO<sub>2</sub> saving over the last 7 days compared to fossil fuels.

E-7d	KWh
Val.	\$
CO2	lb

### Last Month

- E-mon: Total energy output during the month.
- Val.: Money earned during the month
- CO2: CO2 saving compared to fossil fuels during the month.

E-mon	KWh
Val.	S
CO2	lb

### Last 30 Days

- E-30d: Total energy output over the last 30 days.
- Val. : Economic gain over the last 30 days.
- CO2: CO2 saving over the last 30 days compared to fossil fuels.

E-30d	KWh
Val.	S
CO2	lb

### Last 365 Days

- E-365: Total energy output over the last 365 days.
- Val. : Economic gain over the last 365 days.
- CO2: CO2 saving over the last 365 days compared to fossil fuels.

E-365d	KWh
Val.	S
CO2	lb

### User Period

To create a user defined period of time, press ENTER from the 'User period' screen to access the submenu below.

User period
-------------

Use the display keys to set the start and end date of the period as follows:

Start 23 June
End 28 August

- Use ENTER to move from one field to the next (from left to right).
- Use ESC to go back to the previous field (from right to left).
- Press ESC repeatedly to go back to the previous menus.
- To set the day:
  - Press DOWN to scroll numbers backwards (from 31 to 1).
  - Press UP to scroll numbers forwards (from 1 to 31).
- To set the month:
  - Press DOWN to scroll months from December to January.
  - Press UP to scroll months from January to December.

If the dates entered are inconsistent, the display alerts the user to the problem.

Data err
----------

### 4.3.2 SETTINGS MENU

Select **SETTINGS** from the Main Menu display. The first screen requires a password to continue:



The default password is 0000 and can be changed using the keys on the display.

- Use ENTER to move from one digit location to the next (from left to right).
- Use ESC to go back to the previous figure (from right to left).
- Press DOWN to scroll numbers backwards (from 9 to 0).
- Press UP to scroll numbers forwards (from 0 to 9).
- Press ESC repeatedly to go back to the previous menus.

After entering the required password, press **ENTER** to access to the **Settings Menu**:

The front panel display has only two lines and the display keys must be used to scroll through the menu items and/or open the corresponding submenus.

An arrow on left side of the display highlights the current selection. Once the chosen item is selected, press enter to access the desired submenu. The following section provides descriptions of each of the available submenus.

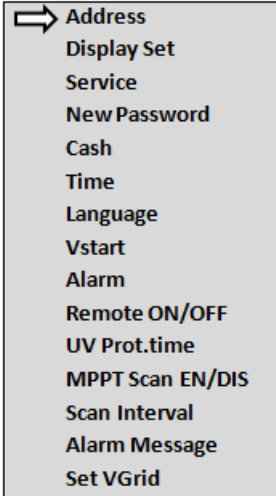

#### Address

Selecting **Address** enables the bus addresses (for the inverter connected to the RS485 communication bus) to be set to an appropriate value

Address values are assigned using any value in the range [2 to 64]. Press the **UP** and **DOWN** keys to scroll through numbers. Press **ENTER** when desired number is displayed.

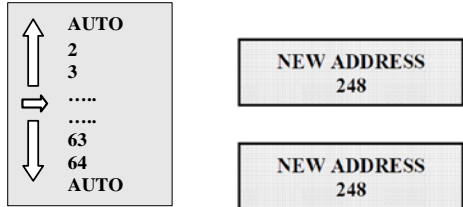

**NOTE: If wiring multiple units using a daisy chain configuration, do not select AUTO configuration.**

### Display Set

Selecting this function displays the submenu enabling the user to set display feature parameters:



- 1) **Light** - select this menu choice to display light settings:  
Select **MODE** to set the display backlighting.

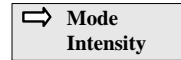

**ON:** Light always ON.

**OFF:** Light always OFF.

**AUTO:** Light turns ON every time a key is pressed and stays on for 30 seconds before fading OFF.



Select **INTENSITY** and enter to adjust the backlighting intensity from 1 to 9.

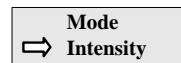

- 2) **Contrast:** Select this menu choice and enter to adjust display lighting contrast



Available display light tones go from 0 to 9. Press UP and DOWN keys to scroll the numbers and then press ENTER to confirm the selection.

- 3) **Buzzer:** Select this menu choice and enter to set key tone setting, choices are:
- **ON:** The key tone is ON.
  - **OFF:** The key tone is OFF.

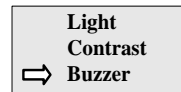

### Service

This is a controlled access area of the operating system used by the factory to set certain control functions. Access is via an Advanced Password, which is a dedicated security code based on the unit serial number and access controlled by Power-One.

Installers may need to access this menu for certain adjustments during the installation process. Power-One will provide Advanced Password access to authorized installers to allow specific actions upon completion of required documentation.

### New Password

Selecting this function allows changing the default password (0000) to a personal code. To set a personal code, use the display keys as follows:

- Use ENTER to move from one digit to the next (from left to right).
- Use ESC to go back to the previous digit (from right to left).
- Press ESC repeatedly to go back to the previous menus.
- Press DOWN to scroll numbers backwards (from 9 to 0).
- Press UP to scroll numbers forwards (from 0 to 9).

### Cash

Selecting this function enables the user to set the measurement units for earnings based on energy output.

**Name:** Set desired currency, using the keys in the usual manner. The default currency is US Dollar.

**Val/KWh:** This indicates the cost of 1 kWh expressed in the currency set. The default setting is Euro 0.50.

Name	\$
Val/KWh	00.50

### Time

Selecting this function allows adjustment of the system time and date settings.

### Language

Selecting this function allows setting of the language desired for system prompts. Choices are Italian or English (default).

### Vstart

Start-up voltage can be set according to the available photovoltaic system. Voltage range can be 120V to 350V. Default setting for Aurora is 200V. This parameter can be changed by means of the display keys.

### Autotest

This is the Aurora inverter's internal test for checking correct operation of the protection and the grid interface device, as provided for by UL 1741 regulation.

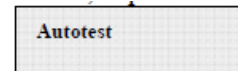

Press **ENTER** to access the following information:

**OV** = Max. voltage

**UV** = Min. voltage

**OF** = Max. Frequency

**UF** = Min. Frequency

**DC injection** = Output current direct component.

This component shall not be >0.5% with respect to inverter maximum rated current or the unit will switch off.

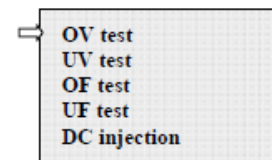

The display has 2 lines; use the keys at the side of the display to scroll through items or open the corresponding submenus. An arrow on left side of the display highlights your current selection. When the chosen item is selected, press **ENTER** to open the submenu.

As soon as a test item is selected, the display shows



During the test the display gives test progress indication. If the test passes the display shows one of the three screens below, depending on which test item was selected.

V= measured voltage

T= time necessary to take the measurement

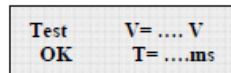

F= measured frequency

T= time necessary to take the measurement

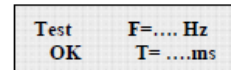

I=measured current

T=time necessary to take the measurement

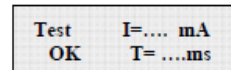

If the test fails, the same information as above is returned with the message **Test Fail** in place of Test OK.

### Alarm

Selecting this function accesses the inverter's alarm function, which is used for external controls or, for example, to activate a visual and/or audible alarm. The function has two different modes of operation.

Select the desired mode using the **UP/DOWN** arrow keys and press **ENTER** to open the relevant submenu:

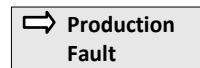

The function controls a set of dry relay contacts, which can be wired by the user as either normally open (N.O.) or normally closed (N.C.); contacts are rated at 250V/1A. The terminals for this function are accessed via the front panel and shown below in Figure 4-3. The two operational modes are described below:

1) **PRODUCTION:** In this mode, the relay is activated only when the inverter is connected to the grid.

For example, if the N.O. (Normally Open) contact is chosen, the contact will remain open (closed) as long as the inverter is not connected to the grid. Once grid connection occurs and the inverter begins to export power, the relay switches its status and closes (opens). Upon disconnection from the grid, the relay contact returns to its rest position, i.e. open (closed).

2) **FAULT:** In this mode, the alarm relay triggers when the system logs a fault condition, based on the error codes (E-code) described in Section 5.3.

For example, if the N.O. (Normally Open) contact is chosen, the contact will remain open (closed) as long as no E-code fault is logged (E-code faults disconnect the inverter from the grid). When any E-code is logged, the relay will change state and stay latched until the next successful grid reconnection, at which time it is reset.

NOTE: the alarm function does not switch when warning codes (W-code) are logged.



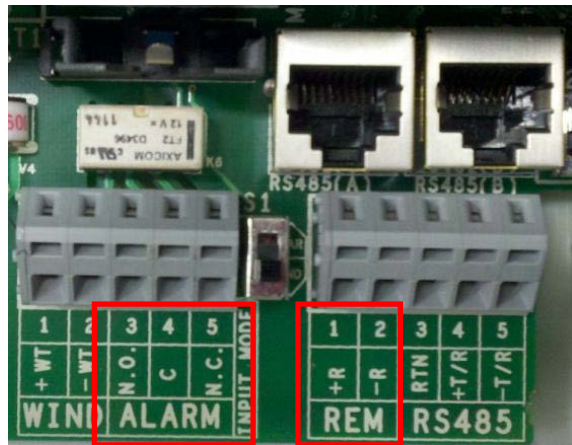

Figure 4-3: Alarm and Remote Contacts Terminal Block

### Remote Control



This function is not available for –A models with AFD; terminal +R is used for AFD and not accessible by the end user.

Selecting this function accesses the remote ON/OFF function used to disable the inverter operation by an external switch or an external controller. Set as follows:

**ENABLE** - Activates the ON/OFF function, requiring an external contact closure to activate the inverter.

Remote ON/OFF  
Enable

**DISABLE**: Disables the ON/OFF function, so that inverter operation will operate normally, depending only on grid access and external solar radiation, (default).

Remote ON/OFF  
Disable

Hardware access to the ON/OFF function is via terminals +R and -R, shown in Figure 4-3. When the function is active,

- Turn **OFF** the inverter terminals by shorting terminals +R and –R.
- Turn **ON** the inverter by removing the short between terminals +R and –R.

With the function enabled, the ON/OFF input status is indicated on the inverter display.

When set to OFF, the display will cycle through the two screens.

Remote OFF

Waiting Rem.ON...  
to restart

### UV Protection Time (PROT. TIME)

Selecting this function allows setting of the inverter connection time after the input voltage drops below the under voltage limit, set at 90V.

For example: If UV Prot.time is set at 60 seconds, and Vin voltage drops below 90V, the inverter stays connected to the grid (at 0 power) for up to 60 seconds afterwards.

The default value is 60 seconds, but can be set over the range of [1 s to 3,600 s].

### MPPT Scan EN/DIS

This function is used to automatically detect input power max multiples and Enable or Disable MPPT scan as necessary.

### Scan Interval

This function is used to set time interval for system max.multiple scan. The default setting is 15 minutes.

### Alarm message

#### Set Vgrid

Selecting this menu opens a sub-menu which allows access for setting the grid type of the inverter connection:

To choose a single phase 208V grid connection, use the **DOWN** arrow key to move to the **208V Single Ph** line and press the **ENTER**.

A second display screen will open; press the **ENTER** key to confirm or **ESC** to go back.

```
⇒ 208V Single Ph
   Vnom = 208V
   277V Single Ph
   Vnom = 277V
   240V Split Ph
   Vnom = 240V
```

```
Vgrid = 208V
Confirm?
```

Similarly, to choose one of the other preset grid voltage/type combinations, move the arrow to the associated row and repeat the steps above.

### 4.3.3 INFO MENU

Selecting the Information menu display the following AURORA Inverter data:

- Part No. (part number)
- Serial No. – Wk – Yr (serial number, week, year)
- Fw rel (firmware revision level)

## 4.4 USING THE AURORA® MANAGER-TL SOFTWARE

This Aurora Manager Software is included on the CD shipped with each inverter and is typically loaded on a laptop PC for portability to the installation site. If this software is not included in the CD, please call Power-One Technical Support 1-877-261-1374.

The installation of this software is optional as most of this functionality can be done through the inverter display. If it is desired to view the basic monitoring and setting options from a computer screen, follow the installation instructions:

- Remove the disk from its cover. Insert the disk into the computer to install the program. The installation will create an icon on the computer desktop.
- Connect the adapter from inverter to the computer. Depending on the configuration determine the type of converter needed (RS485-RS232 or RS485-USB) in section 3.3.3.1 above.



For more a more comprehensive monitoring solution, please see Power-One's AURORA Vision product line at [www.power-one.com](http://www.power-one.com)

### 4.4.1 SERIAL CONNECTION WITH USB PORT

Serial connection through use of the inverter's USB port allows connection of a single inverter to a personal computer equipped with a USB 2.0 interface and dedicated software supplied by Power-One. The PC-inverter connection cable is a standard USB 2.0 cable, 5 meters long, with terminals of the A and B type.

Remove the waterproof plug located on Aurora's side to make the USB connection.



#### 4.4.1.1 *Installation Guide for a Direct Connection from Aurora to Computer via USB Windows XP and 7 (32 & 64 bit)*

A driver installed on a computer or laptop will be necessary to communicate with the Aurora Inverter using a USB connection. Download the driver, *USB Driver Files*, from the installation CD included with this inverter or from the Power-One website and follow the process described below.

- The first **step** extracts the files into the computer (*C:\Program Files\Texas Instruments Inc.*).
- The second **step** installs the actual TUSB3410 driver to the particular Operating System (XP 32 bit, XP 64 bit, Vista 32bit, Vista 64bit, Win7 32bit, Win7 64bit). Below are steps to complete the process.
- The final step connects the inverter to a pc or laptop for communication.

**STEP 1:**

After downloading the .zip file, unzip the "USB Driver Files" and click on **setup.exe**.

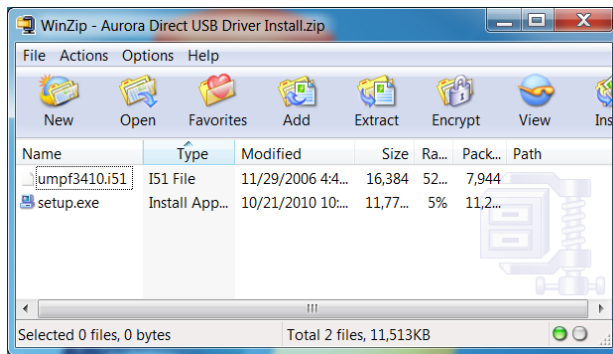

Click on **OK**. This setup will extract all the necessary files to your computer at *C:\Program Files\Texas Instruments Inc.*

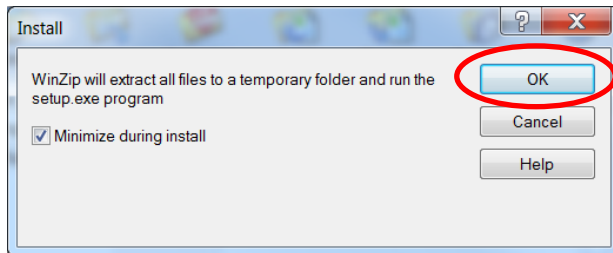

Choose **Accept** from the license agreement screen.

Click **Next** to begin installation.

Continue the TUSB3410 Single Driver Wrapper installation by clicking on **Next**, **Install** and **Finish** to complete.

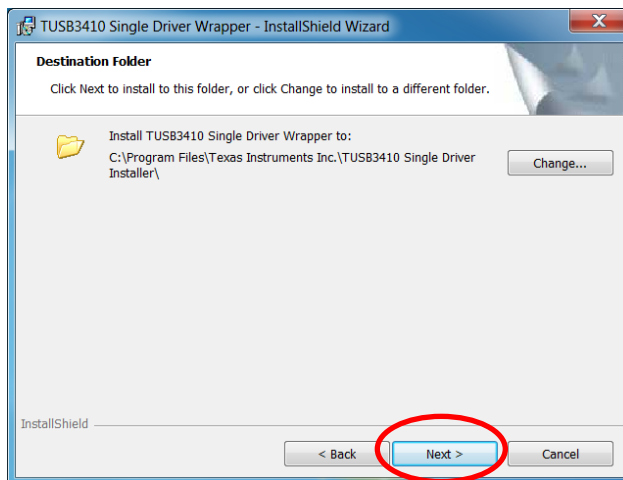

**STEP 2:**

After completing the initial setup, navigate to *Computer -> Local Disk (C:) -> Program Files -> Texas Instruments Inc -> TUSB3410 Single Driver Installer -> DISK1*.

You should see these files in the *DISK1* folder.

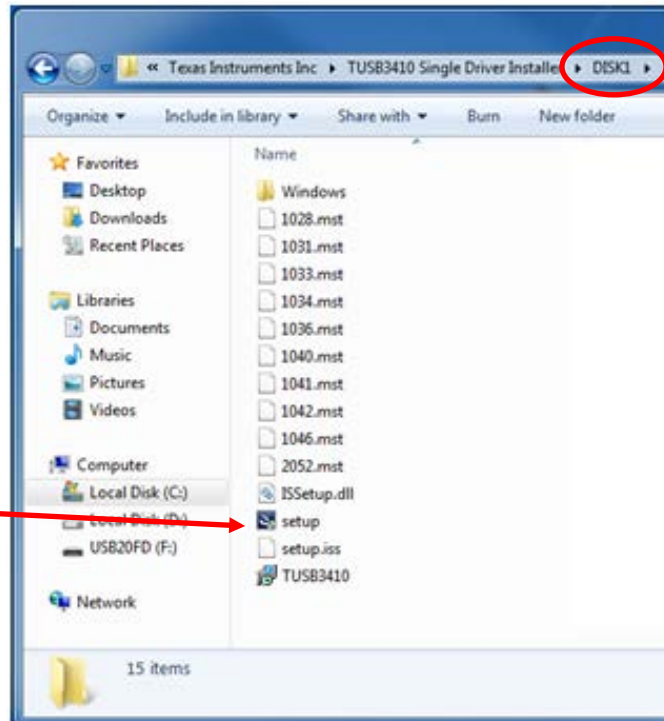

Click on the **setup** icon to install the TUSB3410 VCP driver.

This setup will install the driver on your computer.

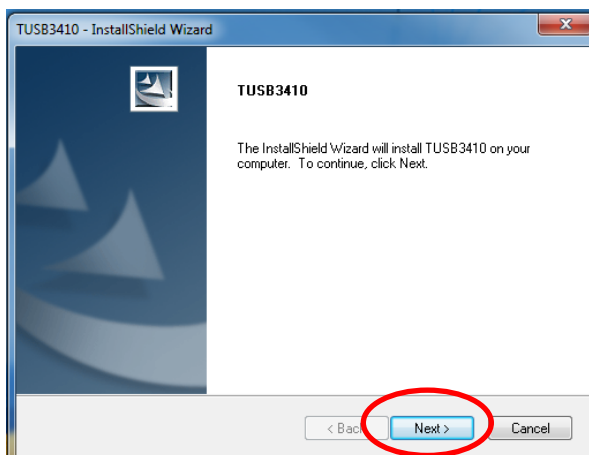

Click **Next** and **Finish** completing the TUSB3410 VCP driver installation.

**STEP 3:**

After completing the installation wizard, plug the USB cable into the computer with the inverter powered **ON** and wait for it to recognize the USB port.

When installed successfully, you will see a pop-up on the bottom right corner of the computer desktop.

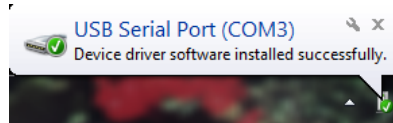

Power **OFF** the inverter.

Copy the **umpf3410.i51** file from the open zip file on the computer.

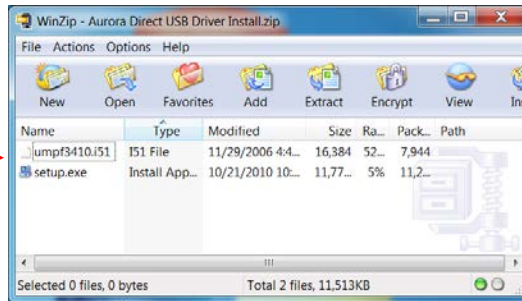

Navigate to *Computer -> Local Disk (C:) -> Windows -> System32 -> Drivers* and **paste** the file, **umpf3410.i51** from the zip file into this *Drivers* folder.

Power the inverter back **ON**. Launch either Aurora Installer or Aurora Communicator(CVI) or Aurora Manager software installed previously on the computer and go to *Configuration -> Communication Setup (ctrl+S)*.

From the Configuration window, use the drop-down arrow to select the port the USB is connected to and click **OK**.

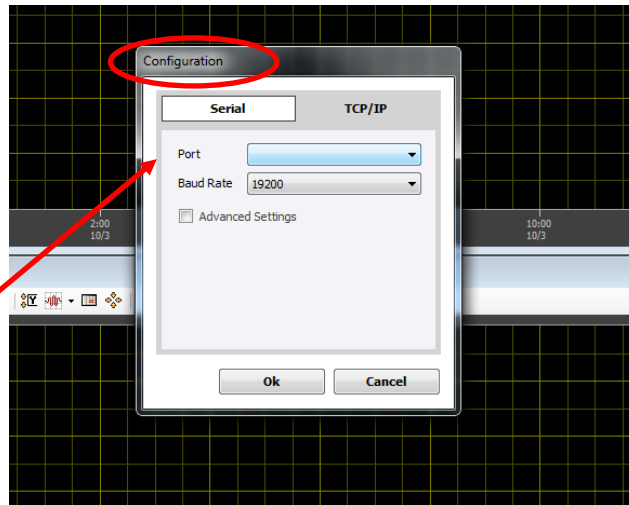

The Aurora Inverter is now ready communicate via the USB connection.

## 4.5 ADJUSTMENTS OF DISCONNECTION PARAMETERS



**Changes to these parameters must be made to meet the requirements of the local utility. Entry of improper values could cause the inverter to shut down.**

If it is necessary to adjust the frequency and disconnect times to meet local utility requirements, modifications are made using the Aurora Manager-TL software. Instructions to download and install the software on a PC can be found on the CD included with this inverter; if an internet connection is available, check the product page at [www.power-one.com/renewable-energy](http://www.power-one.com/renewable-energy) and download the most recent version.

**Prior to connecting to the grid, with the inverter's DC disconnect switch set to ON**, a computer (with software installed) should be connected to the inverter via an RS485-USB adaptor (not included). The USB driver files and instructions for installation can be found on the CD or Power-One website. PC-inverter connection cable requires is standard USB 2.0 cable, terminals type A and B.

The computer loaded with the software must be interfaced to the inverter RS-485 port, utilizing an adapter such as the Aurora **PVI-USB-RS485\_232** adaptor. This device has a port for the RS-485 and a standard USB port for connection to the computer. See section 3.3.2 above for connection via USB.

Once the software is loaded and the computer is interfaced to the inverter, double-click the desktop icon (loaded with software) to open the program and follow the steps below to make the field adjustments.



### STEP 1- Configure the Communication

Click on the Configuration Tab on the Command Bar, as shown below to open the configuration panel.

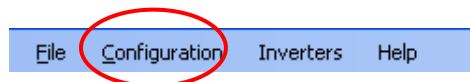

On the *Configuration* panel shown below, select the appropriate COM port assigned to the RS 485 adapter. If this value is unknown, follow the procedure described in the Power One USB-RS485/RS 232 user manual. The other parameters should be left to the default values.



**Serial Port:** COM Port used to communicate with the inverters.  
Set as described in USB-RS485/RS232 user manual.

**Baud Rate:** Speed of the communication line  
(leave the default value: 19200 bit/s)

**Stop Bits:** Stop bit of RS 485 communication.  
Leave the default value: One (1)

**Parity:** Parity bit for error recovery.  
Leave the default value: None

**DTR/RTS Enable:** flag to enable DTR or RTS synchronization.  
Leave the flags *unchecked (disabled)*.

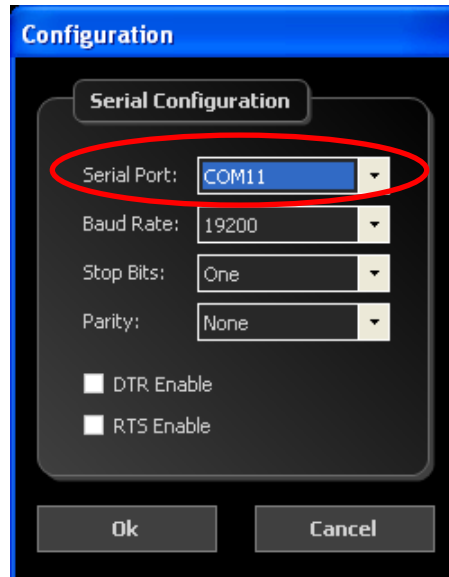

Figure 4-4: Configuration Panel

**STEP 2- Scan the Inverter Bus to acquire the Inverters**

The *Select Mode* panel allows scanning of the communication bus to acquire the inverters. It is possible to choose between *Single Inverter* and *All Inverters*.

**Single Inverter:** insert the inverter address and then press **Start**.

**All Inverter:** by pressing **Scan**, the software will search for all the inverters up to the maximum address configured.

**NOTE:** If it is not possible to find the inverters, check the cabling on the RS 485 Bus and the inverter address from the inverter display.

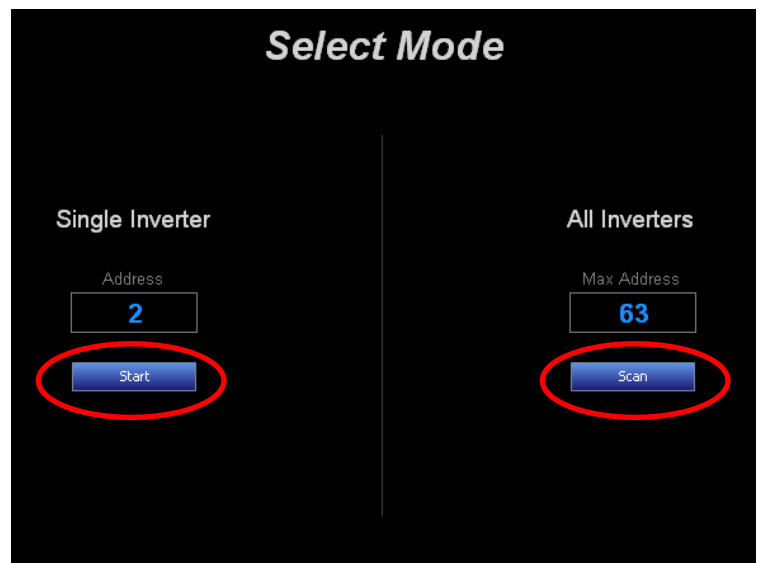

Figure 4-5: Select Mode Panel

### STEP 3- Set the Grid parameters

Aurora Manager TL immediately recognizes the inverter Country and Grid Standard and will display the Voltage and Frequency Parameters according to the Grid requirements ( ).

Press the **READ** button to acquire the actual values. The inverter factory settings cause automatic disconnection from the grid in 160ms when line frequency is outside the range of  $59.3 \text{ Hz} < f < 60.5 \text{ Hz}$ . Press the **WRITE** button to change values of desired parameters to those required by the local utility. The symbols on this screen are defined in Table 4- 1 below.

**NOTE: When the frequency and disconnect time values have been changed, turn OFF and ON the DC power in order to preserve the new data.**

If the inverter’s frequency and disconnect (clearing time) values are field adjusted, apply the label (included in this shipment) to the external, side panel of inverter to indicate the changes.

THIS INVERTER HAS BEEN PROGRAMMED TO AUTOMATICALLY DISCONNECT FROM THE UTILITY DISTRIBUTION SYSTEM WHEN THE FREQUENCY AT THE POINT OF INTERCONNECTION REACHES THE FOLLOWING CONDITIONS:

FREQUENCY CONDITION	DISCONNECT TIME INTERVAL
f > 60.5 Hz	within 0.16 seconds
f = 57 Hz	within 300 seconds
f < 57 Hz	within 0.16 seconds

This screen-shot is the fixed setting defaults per IEEE1547, which states for line frequency, f:

- If f is in the range  $[59.3\text{Hz} \leq f \leq 60.5]$ , the inverter operates normally
- If f falls below 59.3Hz the inverter must disconnect within 160ms

There is only one set point associated with the Under Frequency in this scenario:

- **f< set point** => the frequency value below which the inverter disconnects within 160ms; value used is 59.3Hz
- **Timeout f<** => this timeout is set to 160ms

The voltage values shown are based on the 240V default.

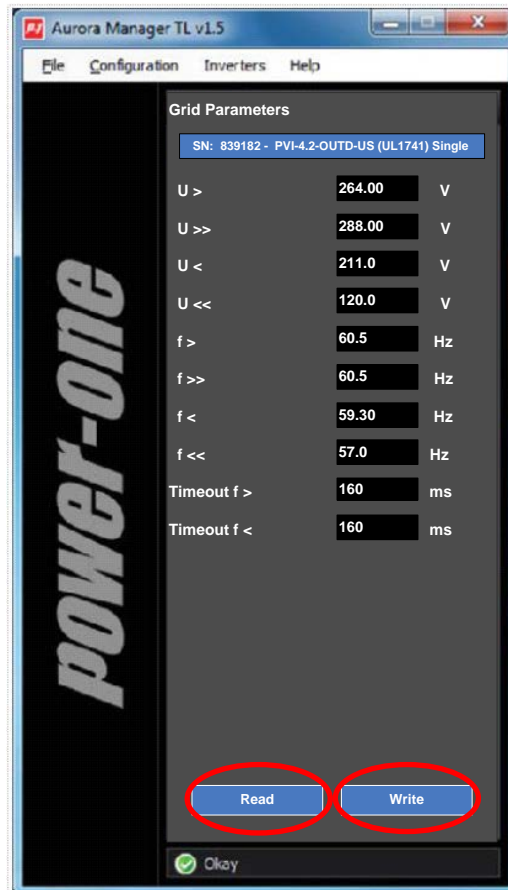

Figure 4-6: Grid Parameters Panel

Table 4- 1: Voltage and Frequency Disconnect Parameters and associated -TL Manager Symbols

-TL Manager Symbol	Factory Default Setting [Range]	Parameter Definition and Action
U>	110% $\times$ V <sub>NOM</sub> [Fixed]	Indicates the value of the intermediate <b>Over Voltage set point</b> <b>Set by control system to 110% of V<sub>NOM</sub> DO NOT CHANGE</b>
U>>	120% $\times$ V <sub>NOM</sub> [Fixed]	Indicates the absolute maximum value of the <b>Over Voltage set point</b> <b>Set by control system to 120% of V<sub>NOM</sub> DO NOT CHANGE</b>
U<	88% $\times$ V <sub>NOM</sub> [Fixed]	Indicates the value of the intermediate <b>Under Voltage set point</b> <b>Set by control system to 88% of V<sub>NOM</sub> DO NOT CHANGE</b>
U<<	50% $\times$ V <sub>NOM</sub> [Fixed]	Indicates the absolute minimum value of the <b>Under Voltage set point</b> <b>Set by control system to 50% of V<sub>NOM</sub> DO NOT CHANGE</b>
f>	60.5 Hz [Fixed]	Indicates the value of the timed <b>Over Frequency setpoint</b> . <b>This parameter is not consistent with UL1741/IEEE1547 certifications and is not applicable to the -TL string inverters. DO NOT CHANGE DEFAULT SETTING</b>
f>>	60.5Hz [Fixed]	Indicates the value of <b>absolute maximum Over Frequency setpoint</b> . For a UL1741/ IEEE1547 certified inverter this value is fixed at 60.5Hz. <b>DO NOT CHANGE</b>
f<	59.3 Hz [57Hz-59.3Hz]	Indicates the value of the <b>adjustable Under Frequency setpoint</b> . For line frequency below this value, a disconnect timer is set to count down the ride through time[Timeout f<] If the timer reaches full count, the inverter will be disconnected from the grid. If the measured frequency rises above this value, the disconnect timer is reset. The default setting indicates the disconnect timer will initiate its count down at 59.3Hz
f<<	57 Hz [Fixed]	Indicates the value of <b>absolute minimum allowable Under Frequency setpoint</b> For a UL1741/ IEEE1547 certified inverter the default value is 59.3Hz, This parameter will cause the inverter to disconnect from the grid within 160ms if the line frequency falls below its set-point value. <b>DO NOT CHANGE DEFAULT SETTING</b>
Timeout f>	160ms [Fixed]	Indicates the initial value of the countdown timer associated with <b>Over Frequency setpoint f&gt;</b> <b>This parameter is not consistent with UL1741/IEEE1547 certifications and is not applicable to the -TL string inverters. DO NOT CHANGE DEFAULT SETTING</b>
Timeout f<	300000ms [160ms -300000ms]	Indicates the initial value of the count down timer associated with Under Frequency set-point f< The value of the timer begins to decrease when line frequency falls below setpoint f<, and resets when the line frequency rises above the value of set point f< The inverter will operate for up to 300000ms (5min) for an under-frequency below the [f<] set-point as long as the frequency does not fall below the [f<<] setpoint
<p>Note that only two highlighted parameters above need to be adjusted to obtain settings for all known adjustable Under Frequency applications</p>		

## PART 5 TROUBLESHOOTING GUIDE

AURORA UNO Inverters comply with the standards set for grid-tied operation, safety, and electromagnetic compatibility. In case of any possible malfunction of the inverter, solve problems as follows:

1. Work under safe conditions. Check that the connections between AURORA, photovoltaic field and power distribution network have been made correctly as stated in Part 1 Introduction & Safety and Part 3 Mounting & Wiring.
2. Carefully observe which LED is flashing and read the signal appearing on the display; try to identify the type of fault found by following the instructions below.

### 5.1 ARC FAULT DETECTION SELF-TEST ERRORS (-A MODELS ONLY)

For –A models only, an autotest circuit is included in the module design of Power-One's DC ARC FAULT DETECTOR and INTERRUPTOR (AFDI) solution. The AFDI performs a self-test when the system is started, (ie every morning when sunlight is sufficient for grid connection). The inverter display shows the results of the self-test :

If the self-test results are OK, the inverter will continue to AC grid connection.

Test ARC  
Sensor OK

***If a potential problem on the AFD board is detected, the self-test will result in error. Refer to Table 5-1 to clear the error and possible solutions.***

AF Self Test  
E053

During normal operation,( while the inverter in connected to the grid), the input current is continually measured and analyzed.

If a DC arc fault is detected, the inverter is disconnected from AC grid and the following error will be shown on the inverter display:

ARC FAULT  
E050

***Press and hold the ESC key for three seconds to clear the error which will start the self-test. If self-test results are OK, the inverter will re-connect to the AC grid. If the DC arc fault is still present, the self test will result in error E053. Refer to Table 5-1 to clear the error and possible solutions.***



**When the AFD protection trips continuously an electrical arcing has taken place. In this case Power-One recommends a complete and accurate check of DC connections.**

The AF self test can be manually started anytime using the following procedure:

1. Turn off the inverter (switching off both DC and AC switches) and,
2. Turn on both the DC and AC switches waiting for display communication of self-test result.

## 5.2 DISPLAY MESSAGES AND ERROR CODES

The system status is identified through message or error signals displayed on the LCD display. The following table briefly describes the two types of signals which may be displayed.

**Messages** identify the current status of the Aurora inverter. Messages do not relate to a fault. When a **(W)** with a number after it appears in the display, it indicates a **Warning Code** and is usually cleared through an orderly shutdown/re-set or a self corrective action performed by the inverter. See the **(W)** codes in the following table.

**Alarms** or **(E)** codes identify a possible equipment failure, fault or incorrect inverter setting or configuration. However, some of the **(E)** codes may require you to contact Power-One Technical Support to assist in correcting a fault. Any and all attempts to correct or clear a fault must be performed by qualified personnel. Typically, the **(E)** code can be cleared once the cause or fault is removed. Some of the **(E)** codes, **(Int. Error)** as indicated in the table below, may indicate a fatal error and require you to contact Power-One technical support for diagnostics and / or a product replacement.

Table 5-1: Display Messages and Error Codes

<i>Display Message</i>	<i>Causes</i>	<i>Solution</i>
Ground Fault Red LED	The alarm is generated when a ground leakage current is detected in the DC section of the system. The alarm is accompanied by the lighting up of the red LED on the front of the inverter.	If possible, measure the insulation resistance using a megohmmeter positioned between the photovoltaic field (positive terminal short-circuited to the negative pole) and ground. If the measured value is less than 1 mega ohm, the photovoltaic generator must be checked by a technician/installer to identify and eliminate the problem. If the measured value is greater than 1 mega ohm and the error warning continues to be present, contact Power-One Service.
<b>E001</b> <b>Input OC</b>  Input Overcurrent	The alarm appears when the inverter input current exceeds the set overcurrent threshold.	Check whether the composition of the PV generator allows an input current that exceeds the maximum threshold allowed by the inverter and that the configuration of the (independent or parallel) inputs is carried out correctly. If the configuration of the PV generator and the setting of the input channels are suitable, contact Power-One Service.
<b>E002</b> <b>Input OV</b>  Input Overvoltage	This alarm is indicated when the inverter input voltage (coming from the PV generator) exceeds the operating threshold. The alarm is triggered before reaching the absolute threshold beyond which the inverter will be damaged. When the inverter input voltage exceeds the Over Voltage threshold, the inverter will not start because of the generation of the alarm.	Measure the input voltage in the inverter with a voltmeter. If it is higher than the maximum voltage of the operating interval, the alarm is real. Check the configuration of the PV generator. If it is lower than the maximum voltage of the operating interval, the alarm is caused by an internal malfunctioning; contact Power-One Service

<i>Display Message</i>	<i>Causes</i>	<i>Solution</i>
<p><b>E003</b> <b>No Parameters</b></p> <p>Internal Parameters Error</p>	<p>The main microcontroller is unable to correctly initialize the two DSPs (booster stage and inverter stage). This is usually due to communication problems on the internal bus of the inverter.</p>	<p>This is an error inside the inverter that cannot be checked externally. If the problem persists (after switching the inverter off and then on again), contact Power-One Service.</p>
<p><b>E004</b> <b>Bulk OV</b></p> <p>Bulk Overvoltage</p>	<p>Error inside the inverter. The alarm is raised when the voltage at the ends of the bulk capacitors exceeds the Over Voltage threshold.</p>	<p>The alarm can be caused by causes external to the inverter: an excessive inverter input voltage can be detected as a bulk overvoltage condition. In this case, it is advisable to check the inverter input voltage and, if this value is near the input OV threshold, re-examine the configuration of the photovoltaic generator. The alarm can be caused by causes internal to the inverter; contact Power-One Service.</p>
<p><b>E005</b> <b>Comm.Error</b></p> <p>Internal Communication Error</p>	<p>The alarm occurs when there are communication problems between the control devices inside the inverter.</p>	<p>Error inside the inverter that cannot be checked externally. If the problem persists (after switching the inverter off and then on again), contact Power-One Service.</p>
<p><b>E006</b> <b>Output OC</b></p> <p>Output Overcurrent</p>	<p>The alarm appears when the inverter output current exceeds the output overcurrent threshold of the inverter.</p>	<p>Error inside the inverter that cannot be checked externally. If the problem persists (after switching the inverter off and then on again), contact Power-One Service.</p>
<p><b>E007</b> <b>IGBT Sat</b></p> <p>IGBT Saturation</p>	<p>The alarm appears when one of the active devices of the inverter is in saturation state.</p>	<p>Once the error appears, the inverter attempts to resume normal operation. If the error occurs sporadically, it may be caused by a sharp transition of the grid voltage or the input voltage but is not attributable to inverter malfunctioning. If the error is associated with an internal fault, it will continue to appear; contact Power-One Service.</p>
<p><b>E009</b> <b>Internal error</b></p>	<p>Error inside the inverter</p>	<p>Error inside the inverter that cannot be checked externally. If the problem persists (after switching the inverter off and then on again), contact Power-One Service.</p>
<p><b>E010</b> <b>Bulk Low</b></p> <p>Low Bulk Voltage</p>	<p>The alarm can be triggered by causes external to the inverter: a low inverter input voltage (just above the activation voltage) that is not accompanied by sufficient availability of power from the photovoltaic generator (typical condition of periods of insufficient irradiation).</p>	<p>If the error warning appears sporadically, it can be attributed to causes external to the inverter (insufficient irradiation, and therefore little power available from the PV generator). If the problem appears systematically even in conditions of high solar radiation and with input voltage significantly higher than the activation voltage, contact Power-One Service.</p>
<p><b>E011</b> <b>Ramp Fail</b></p> <p>Bulk ramp timeout</p>	<p>Error inside the inverter regarding the time for starting steady state operation of the DC-DC circuit part (Booster).</p>	<p>Error inside the inverter that cannot be checked externally. If the problem persists (after switching the inverter off and then on again), contact Power-One Service.</p>

<i>Display Message</i>	<i>Causes</i>	<i>Solution</i>
<p><b>E012</b> <b>DcDc Fail</b></p> <p>Booster module error revealed by Inverter</p>	<p>Error inside the inverter regarding the operation of the DC-DC circuit part (Booster).</p>	<p>Error inside the inverter that cannot be checked externally. If the problem persists (after switching the inverter off and then on again), contact Power-One Service.</p>
<p><b>E013</b> <b>Wrong Mode</b></p> <p>Wrong Input Mode (parallel instead of independent)</p>	<p>The alarm is generated only when the inverter is configured with parallel inputs. In this particular configuration, the inverter carries out the input voltage check of each of the two channels, and the alarm is raised if the two voltages differ by more than 20Vdc.</p>	<p>Make sure the setting of the "IN MODE" switch has been intentionally positioned on "PAR" and that the jumpers have been inserted between the two input channels. If the configuration of the inverter is correct, check that the input strings have the usual number of panels in series, of the usual make and with the same inclination/orientation. If both the configuration of the inverter and the characteristics of the PV generator comply with the specifications, contact Power-One Service.</p>
<p><b>E014</b> <b>Over Temp.</b></p> <p>Over- temperature</p>	<p>External temperature above 60°C. This parameter also depends on the power that the inverter must supply since the measurement of the temperatures is carried out internally and is affected by the heat dissipated by the components of the inverter.</p>	<p>Wait for the temperatures to which the inverter is exposed to return within operating range and for the inverter to cool down. If the problem persists (once the ambient temperature has returned within the range), contact Power-One Service. Remember to wait for the time necessary to allow the inverter to cool down.</p>
<p><b>E015</b> <b>Bulk Cap Fail</b></p>	<p>Error inside the inverter regarding a problem in the bulk capacitors.</p>	<p>Error inside the inverter that cannot be checked externally. If the problem persists (after switching the inverter off and then on again), contact Power-One Service.</p>
<p><b>E016</b> <b>Inverter Fail</b></p> <p>Inverter module error revealed by Booster</p>	<p>The alarm is generated when a problem is detected in the inverter circuit part (DC/AC).</p>	<p>Error inside the inverter that cannot be checked externally. If the problem persists (after switching the inverter off and then on again), contact Power-One Service.</p>
<p><b>E017</b> <b>Start Timeout</b></p> <p>Inverter module start- up timeout</p>	<p>Error inside the inverter regarding the time for starting steady state operation of the DC-AC circuit part (Inverter).</p>	<p>Error inside the inverter that cannot be checked externally. If the problem persists (after switching the inverter off and then on again), contact Power-One Service.</p>
<p><b>E018</b> <b>Ground Fault</b></p> <p>Leakage current fail</p>	<p>The alarm is generated when, during normal operation of the inverter, a ground leakage current is detected in the DC section of the system. The alarm is accompanied by the lighting up of the red LED on the front of the inverter. The inverter may even also generate the E018 alarm message for AC leakage currents associated with the capacitive nature of the photovoltaic generator compared to ground.</p>	<p>If possible, measure the insulation resistance using a megohmmeter positioned between the photovoltaic field (positive terminal short-circuited to the negative pole) and ground. If the measured value is less than 1 mega ohm, the PV generator must be checked by a technician/installer to identify and eliminate the problem. If the measured value is greater than 1 mega ohm and the error warning continues to be present, contact Power-One Service.</p>



<i>Display Message</i>	<i>Causes</i>	<i>Solution</i>
<p><b>E019</b> <b>Self-Test Error 3</b></p> <p>Leakage current sensor self- test fail</p>	<p>Before connecting to the grid, the inverter carries out an autotest that tests the leakage current sensor. The test is carried out by “forcing” a current of known value in the leakage current sensor: the microprocessor compares the read value with the known value. The error is generated if the comparison between the read value and the known value during the test is not within the allowed tolerance.</p>	<p>This is an error inside the inverter that cannot be checked externally. If the problem persists (after switching the inverter off and then on again), contact Power-One Service. By its nature, the alarm appears only before connection to the grid.</p>
<p><b>E020</b> <b>Self-Test Error 1</b></p> <p>Booster relay self-test fail</p>	<p>Before connecting to the grid, the inverter carries out some internal tests. One of these tests regards the correct operation of the booster relay. The test is carried out by “forcing” the switching of the relay and checking its functionality. The error is generated if a problem is found with the operation of the relay.</p>	<p>This is an error inside the inverter that cannot be checked externally. If the problem persists (after switching the inverter off and then on again), contact Power-One Service. By its nature, the alarm appears only before connection to the grid.</p>
<p><b>E021</b> <b>Self-Test Error 2</b></p> <p>Inverter relay self-test fail</p>	<p>Before connecting to the grid, the inverter carries out a test that regards the operation of the inverter relay. The test is carried out by “forcing” the switching of the relay and checking its functionality. The error is generated if a problem is found with the operation of the relay.</p>	<p>This is an error inside the inverter that cannot be checked externally. If the problem persists (after switching the inverter off and then on again), contact Power-One Service. By its nature, the alarm appears only before connection to the grid.</p>
<p><b>E022</b> <b>Self-Test Error 4</b></p> <p>Relay self- test timeout</p>	<p>Time taken to execute the autotest carried out on the relays of the DC_AC circuit part (inverter) is too long. This may indicate a problem associated with the aforesaid relays.</p>	<p>Error inside the inverter that cannot be checked externally. If the problem persists (after switching the inverter off and then on again), contact Power-One Service.</p>
<p><b>E023</b> <b>DC inj error</b></p> <p>Dc-Injection out of range</p>	<p>The error is generated if the direct component of the current supplied to the grid exceeds the threshold of 0.5% of the rated operating current. In any case, the inverter does not stop because of the E023 error, but tries to connect to the grid again. Sporadic repetition of the error is a sign of large grid distortions or sudden changes in irradiation, whereas systematic repetition of the error warning will be a sign of an inverter fault.</p>	<p>If the grid voltage is strongly distorted, report this anomaly to the grid company for the resolution of the problem. If there is an inverter fault, contact Power-One Service.</p>

<i>Display Message</i>	<i>Causes</i>	<i>Solution</i>
<b>E024</b> <i>Internal error</i>	Error inside the inverter	Error inside the inverter that cannot be checked externally. If the problem persists (after switching the inverter off and then on again), contact Power-One Service.
<b>E025</b> <i>Riso Low(not shown on the display)</i>  Low insulation resistance	Before connecting to the grid, the inverter measures the insulation resistance of the PV generator compared to ground. If the insulation resistance measured by the inverter is less than 1 MOhm, the inverter does not connect to the grid and shows the "Riso Low" error. The causes may be: - Damaged PV panel(s). - Junction box(es) of the panels not properly sealed, so allowing water and /or damp seepage ; - Problems in the connections between panels (not perfectly connected); - Poor quality cable junctions; - Presence of unsuitable (trigger voltage lower than the characteristics of the PV generator strings) or damaged overvoltage surge arresters outside the inverter in the DC section. - Presence of damp inside the field panel, if there is one.	If possible, measure the insulation resistance using a megohmmeter positioned between the photovoltaic field (positive terminal short-circuited to the negative pole) and ground (as described in the relevant section: "checking the ground insulation of the PV generator"). If the measured value is less than 1 mega ohm, the photovoltaic generator must be checked by a technician/installer to identify and eliminate the problem. If the measured value is greater than 1 mega ohm and the error warning continues to be present, contact Power-One Service.  (Damp increases leakage and can therefore be the cause of a reduction in insulation resistance).
<b>E02</b> <i>Vref Error</i>  Bad internal reference voltage	Wrong measurement of the reference voltage inside the equipment.	Internal error that cannot be checked externally. If the problem persists (even after switching the inverter off and then on again), contact Power-One Service.
<b>E027</b> <i>Error Meas V</i>  VGrid Measures Fault	Error in the internal measurement of the grid voltage (imposed by regulations) to have a measurement redundancy (2 measurements on the same parameter carried out by two different circuits).	This is an error inside the inverter that cannot be checked externally. If the problem is persistent (even after switching the inverter off and then on again), contact Power-One Service.
<b>E028</b> <i>Error Meas F</i>  FGrid Measures Fault	Error in the internal measurement of the grid frequency (imposed by regulations) to have a measurement redundancy (2 measurements on the same parameter carried out by two different circuits).	This is an error inside the inverter that cannot be checked externally. If the problem is persistent (even after switching the inverter off and then on again), contact Power-One Service.

<i>Display Message</i>	<i>Causes</i>	<i>Solution</i>
<b>E029</b> <b>Error Meas Z</b>  ZGrid Measures Fault	Error in the internal measurement of the insulation resistance of the PV generator compared to ground (imposed by regulations) to have a measurement redundancy (2 measurements on the same parameter carried out by two different circuits).	Error inside the inverter that cannot be checked externally. The error occurs if the internal measurement is carried out before connection to the grid) If the problem is persistent (even after switching the inverter off and then on again), contact Power-One Service.
<b>E030</b> <b>Error Meas ILeak</b>  ILeak Measures Fault	Error in the internal measurement (carried out when the inverter is connected to the grid) of the leakage current of the DC side (PV generator) compared to ground (imposed by regulations) to have a measurement redundancy (2 measurements on the same parameter carried out by two different circuits).	This is an error inside the inverter that cannot be checked externally. If the problem is persistent (even after switching the inverter off and then on again), contact Power-One Service.
<b>E031</b> <b>Error Read V</b>  Wrong V Measure	Measurement of the internal voltage at the ends of the output relay out of range. There is too great a difference in voltage between the input and the output of the output relay.	This is an error inside the inverter that cannot be checked externally. If the problem appears repeatedly, contact Power-One Service.
<b>E032</b> <b>Error Read I</b>  Wrong I Measure	Measurement of the output voltage unbalance (carried out between the three phases) out of range (only in three-phase models).	This is an error inside the inverter that cannot be checked externally. If the problem appears repeatedly; contact Power-One Service.
<b>E033</b> <b>UTH</b> Under Temperature	Temperature outside the inverter below -25°C	Wait for the temperatures to which the inverter is exposed to return within operating range. If the problem persists, contact Power-One Service. Remember to wait for the time necessary to allow the inverter to warm up.
<b>E034</b> <b>Interlock fail</b> IGBT not ready	Error inside the inverter	Error inside the inverter that cannot be checked externally. If the problem persists (after switching the inverter off and then on again), contact Power-One Service.
<b>E035</b> <b>Remote Off</b> (not shown on the display)  Waiting remote ON	The inverter has been switched off remotely (remote OFF) and remains in waiting state for the signal that will switch it on again (remote ON).	Switch on the inverter remotely. If the unit does not switch on, disable the remote on/off function and switch the equipment off completely and then switch it on again. If the problem persists (after re-enabling the Remote ON/OFF function from the display), contact Power-One Service.

<i>Display Message</i>	<i>Causes</i>	<i>Solution</i>
<p><b>E036</b> <b>Vout Avg error</b></p> <p>Average Vout out of range</p>	<p>The average grid voltage value (every 10 minutes) does not fall within the allowed ranges. The grid voltage at the point connected to the inverter is too high. This may be caused by grid impedance that is too high. Towards the end of the timeout, the inverter limits the power to check whether the grid voltage stabilizes within the normal parameters. If this does not happen, the inverter disconnects from the grid.</p>	<p>Check the grid voltage at the inverter connection point. If the grid voltage diverges from the range because of grid conditions, ask the grid company to adjust the grid voltage. If the grid company authorizes a change to the inverter parameters, arrange the new limits with Power-One Service.</p>
<p><b>E037</b> <b>Riso Low</b></p> <p>Low insulation resistance (amorphous mode only)</p>	<p>This error can appear only if the “Amorphous” mode is enabled. This function is enabled only in inverters equipped with grounding kit and is used to monitor the voltage at the ends of the grounding resistor. The error appears when the voltage at the ends of the resistor connected between ground and pole of the photovoltaic generator exceeds 30V for more than 30 minutes or 120V for more than one second.</p>	<p>Check for the presence and correct contacting of the two terminals of the grounding resistor installed inside the inverter.</p> <p>If possible, measure the insulation resistance using a megohmmeter positioned between the PV field (positive terminal short-circuited to the negative pole) and ground (as described in the operation chapter).</p> <p>If the measured value is less than 1 mega ohm, the photovoltaic generator must be checked by a technician/installer to identify and eliminate the problem.</p> <p>If the measured value is greater than 1 mega ohm and the error warning continues to be present, contact Power-One Service.</p>
<p>Mid Bulk OV</p>	<p>NA</p>	<p>NA</p>
<p><b>E050</b> <b>Arc Fault</b> (-A version ONLY) DC Arc detected</p>	<p>An electrical arc has been detected on DC cables. This error latches the inverter in a disconnected state.</p>	<p>Check DC cables and connections to identify the source of possible arcing. Press ESC like indicated in the display in order to unlatch the inverter.</p>
<p><b>E053</b> <b>AF Self-Test</b> (-A version ONLY) Arc fault detector (AFD) sensor Self-test failed</p>	<p>Self-Test performed by AFD board failed. The board will try another self-test after user turns inverter off and on.</p>	<p>Press ESC as indicated in the display in order to unlatch the inverter. If the problem persists (after switching the inverter off and on), contact Power-One Service.</p>
<p><b>W001</b> <b>Sun Low</b> (Low input voltage during switch-on of the inverters)</p>	<p>Insufficient irradiation. Wrong configuration of the PV generator or a configuration “at the limit” as regards the minimum input voltage of the inverter.</p>	<p>Check the inverter input voltage.</p> <p>If it does not exceed the Vstart, check that there is sufficient irradiation and that the composition of the system is correct. If it exceeds the Vstart, contact Power-One Service.</p>
<p><b>W002</b> <b>Input UV</b> (Low input voltage during switch-off)</p>	<p>Insufficient irradiation Wrong configuration of the photovoltaic generator or a configuration “at the limit” as regards the minimum input voltage of the inverter.</p>	<p>Check the inverter input voltage.</p> <p>If it does not exceed the Vstart, check that there is sufficient irradiation and that the composition of the system is correct. If it exceeds the Vstart, contact Power-One Service.</p>

<i>Display Message</i>	<i>Causes</i>	<i>Solution</i>
<p><b>W003</b> <b>Grid Fail</b></p> <p>Grid Fail (grid voltage parameters outside the limits)</p>	<p>This error warning appears during normal operation of the inverter when the grid parameters fall outside the limits set by the grid company. No grid voltage (after the warning, the inverter goes on "No Vac") Unstable grid voltage (downwards and upwards) Unstable grid frequency.</p>	<p>Check the grid voltage on the inverter. If absent, check for the absence of grid voltage on the supply. If the voltage tends to rise (when the inverter is connected), it means there are high line or grid impedances. Check the grid voltage on the supply as well; if it is high, it means there is high grid impedance. In this case, ask the grid company to adjust the grid voltage. If the grid company authorizes a change to the inverter parameters, arrange the new limits with the Power-One Service. If the voltage at the supply point is much lower than that measured on the inverter, the line must be adjusted (inverter- counter). If the grid voltage and frequency fall within the limits (even when the inverter is connected to the grid), contact Power-One Service.</p>
<p><b>W009</b> <b>Table fail</b></p>	NA	NA
<p><b>W010</b> <b>Fan Fail</b></p> <p>(Alarm not shown on the display; there is only a flashing yellow LED)</p>	<p>This error appears when there is malfunctioning of the fan(s) inside the inverter. In this condition, the yellow LED on the front panel flashes.</p>	<p>Error inside the inverter that cannot be resolved with external operations. If the alarm is persistently repeated, contact Power-One Service.</p>
<p><b>W011</b> <b>Bulk UV</b></p>	<p>Reading of the internal voltage on the bulk capacitors carried out when the inverter is connected to the grid.</p>	
<p><b>W012</b> <b>Battery low</b></p> <p>Low internal clock battery voltage</p>	<p>Internal battery for maintenance of the date/time settings is discharged or damaged.</p>	<p>Replace the battery with the inverter completely switched off (disconnect AC side and DC side) and be sure to observe the correct polarity.</p>
<p><b>W013</b> <b>Clk fail</b></p> <p>Internal clock failure</p>	<p>The alarm appears when the time shown on the display differs by more than 1 minute from the internal time of the microprocessors and indicates clock circuit malfunctioning.</p>	<p>This is an error inside the inverter that cannot be resolved with external operations. If the alarm is persistently repeated, contact Power-One Service.</p>
<p><b>W017</b> <b>Jbox fail</b></p> <p>Fuse-control board fail (DC string fail)</p>	<p>Fuse(s) on the fuse boards is/are damaged.</p>	<p>Using a multimeter, check the condition of the fuses (situated on the fuse boards). Replace any open fuses and check that the input current on the string(s) does not exceed the rating of the fuses (if string parallels have been made outside the inverter). If there are no damaged string fuses and the inverter continues to display the alarm message, check whether the settings to be made through the Aurora Manager software are correct (presence or absence of one or more input strings).</p>

<i>Display Message</i>	<i>Causes</i>	<i>Solution</i>
<b>W018</b> <b>SPD DC protection</b> <b>open</b>	Overvoltage surge arresters situated on the DC side are damaged.	Look at the inspection window present on each surge arrester (DC side). If it is red, the surge arrester is damaged and the cartridge must be replaced. If the alarm status continues to be present even though all the surge arresters have a green inspection window, contact Power-One Service.
<b>W019</b> <b>SPD AC protection</b> <b>open</b>	Overvoltage surge arresters situated on the AC side are damaged.	Look at the inspection window present on each surge arrester (AC side). If it is red, the surge arrester is damaged and the cartridge must be replaced. If the alarm status continues to be present even though all the surge arresters have a green inspection window, contact Power-One Service.

### 5.3 THE POWER ONE SERVICE CALL

#### **INFORMATION ON AURORA UNO INVERTER**

- |   |
|---|
| <ul style="list-style-type: none"> <li>A. AURORA model?</li> <li>B. Serial number?</li> <li>C. Week of production?</li> <li>D. Which LED is flashing?</li> <li>E. Steady or flashing light?</li> <li>F. What signals are shown on the display?</li> </ul> |
|---|

**NOTE:** Information items A, B, and C above are available directly from the INFO menu of the LCD display.

Additional helpful information when troubleshooting with the Power-One Technical Service Engineers:  
Provide a brief description of the fault.

- Information on the Photovoltaic Field
- Brand and model of photovoltaic panels
- Identify the System structure:
  - Maximum array voltage and current values
  - Number of strings in the array
  - Number of panels for each string
  - Can the fault be reproduced? If so, how?
  - Is the fault cyclical in nature? If so, how often?
  - Was the fault apparent at the time of installation?
  - If so, has it got worse?
  - Describe the atmospheric conditions at the time the fault appears/appeared.

#### **Power-One Technical Support**

Phone: 1-877-261-1374

---

## PART 6 MAINTENANCE GUIDE

---

Checking and maintenance operations must be carried out by specialized staff assigned to carry out this work. DO NOT allow the equipment to be used if problems of any kind are found, and restore the normal conditions correctly or make sure this is done.

**Maintenance operations must be carried out with the equipment disconnected from the grid, unless otherwise indicated.**



**For cleaning, DO NOT use rags made of filamentary material or corrosive products that may corrode parts of the equipment or generate electrostatic charges.**

**Avoid temporary repairs. All repairs should be carried out using only genuine spare parts. The maintenance technician is under an obligation to promptly report any anomalies.**

**Always use the personal protective equipment provided by the employer and comply with the safety conditions in Part 1 of this manual.**

### 6.1 POWER-DOWN PROCEDURES



**THE FOLLOWING OPERATIONS MUST ALWAYS BE PERFORMED before accessing the power input of the Switch Box in order to avoid injury to personnel and/or damage to equipment.**

**To avoid the risk of electric shock from energy stored in capacitors, wait at least ten minutes after disconnecting both AC and DC sides before opening the front panel.**

Once the inverter is wired and connected to the grid use the following procedures to disconnect for maintenance:

Disconnect from the AC Grid by one of the following methods:

- Turn-OFF the external AC switch
- Turn-OFF the Over Current Protection Device (circuit breaker)

Disconnect the inverter from the PV array by turning OFF the external DC disconnect switch.

**NOTE: When possible, turn off the AC switch first, however, there is no specific order for turning off the two switches.**

Cover all the photovoltaic panels using appropriate cover or perform the grid CONNECTION and/or DISCONNECTION operation during night hours. Ensure that no photovoltaic panel can provide energy during this operation.

Remove the inverter cover (section 3.2.2). Using a voltmeter, check voltage levels at the DC input terminals and the AC output cables to ensure no hazardous voltages are present.

## 6.2 ROUTINE MAINTENANCE

Routine maintenance is recommended to maintain efficient operation of the PV installation.

**Table 6-1: Recommended Periodic Maintenance**

<b>Annual visual inspection</b>	<ul style="list-style-type: none"> <li>• Check that all labels and safety symbols are visible;</li> <li>• Check that the environmental conditions have not changed drastically (exposure to weather condition);</li> <li>• Check that the inverter or PV panels have not been shaded or isolated by foreign bodies.</li> </ul>
<b>Annual operations</b>	<ul style="list-style-type: none"> <li>• Check the tightness of the cable opening plugs;</li> <li>• Check the fitting of the connectors and front covers (loose fittings can allow water seepage into the cabinet which may result in short circuits due to humidity).</li> </ul>
<b>Annual cleaning</b>	<ul style="list-style-type: none"> <li>• Clean the equipment; verify that no obstructions are present on the fins of the heat sink. If possible, use an extractor or suitable pipe cleaners.</li> </ul>

## 6.3 CR2032 LITHIUM BATTERY REPLACEMENT



**WARNING:** The replacement of the battery should be performed only by trained personnel.

The replacement of the internal battery must be carried out when the display shows the error W012 “Battery Low” or the settings of current date/time are frequently reset.

The battery is visible after removing the AURORA PV Inverter's front panel. Refer to Part 3, section 3.2.2 for the procedure to remove the front panel. Extract the battery from its housing with a 30° tilt.

Insert the replacement battery into the housing at a 30° angle. When pushed in the battery should seat into the correct position within the holder. Reinstall and tighten the cover screws with at least 1.5Nm (13.2 in-lbs) torque.

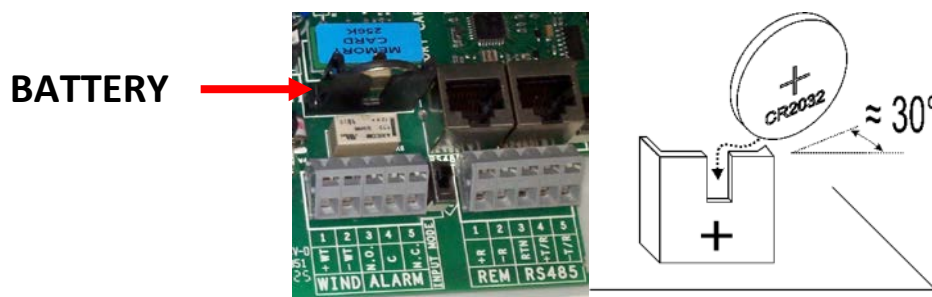

**Figure 6- 1: Internal battery replacement**



## 6.4 STORAGE AND DISMANTLING

### 6.4.1 STORAGE OF THE EQUIPMENT OR PROLONGED STOP

If the equipment is not used immediately or is stored for long periods, check that it is correctly packed and contact **Power-One** for storage instructions. The equipment must be stored in well-ventilated indoor areas that do not have characteristics that might damage the components of the equipment.

Restarting after a long or prolonged stop requires a check and, in some cases, the removal of oxidation and dust that will also have settled inside the equipment if not suitable protected.

### 6.4.2 DISMANTLING, DECOMMISSIONING AND DISPOSAL

**Power-One** CANNOT be held responsible for disposal of the equipment: displays, cables, batteries, accumulators, etc., and therefore the customer must dispose of these substances, which are potentially harmful to the environment, in accordance with the regulations in force in the country of installation.

If the equipment is dismantled, to dispose of the products it consists of, you must stick to the regulations in force in the country of destination and in any case avoid causing any kind of pollution.

***Dispose of the various types of materials that the parts of the equipment consist of in dumps that are suitable for the purpose.***

Table 6- 1: Component Disposal

COMPONENT	MATERIAL OF CONSTRUCTION
Frame, brackets, supports	Arc-welded steel FE37
Casing or covers	ABS, Plastic
Paint	RAL
Gaskets and seals	Rubber / Teflon / Viton
Electrical cables	Copper / Rubber
Cable trays	Polyethylene / Nylon
Backup battery	Nickel / Lead / Lithium

# PART 7 APPENDIX

## 7.1 DATA SHEETS

Table 7-1: Technical Data

TECHNICAL DATA	VALUES	PVI-5000-OUTD-US			PVI-6000-OUTD-US		
Nominal Output Power	W	5000			6000		
Maximum Output Power	W	5000			6000		
Rated Grid AC Voltage	V	208	240	277	208	240	277
Input Side (DC)							
Number of Independent MPPT Channels		2			2		
Maximum Usable Power for Each Channel	W	4000			4000		
Absolute Maximum Voltage (Vmax)	V	600			600		
Start-Up Voltage (Vstart)	V	200 (adj. 120-350)			200 (adj. 120-350)		
Full Power MPPT Voltage Range	V	200-530			200-530		
Operating MPPT Voltage Range	V	0.7xVstart-580			0.7xVstart-580		
Maximum Current (I <sub>dcmax</sub> ) for both MPPT in Parallel	A	36			36		
Maximum Usable Current per Channel	A	18			18		
Maximum Short Circuit Current Limit per Channel	A	22			22		
Number of Wire Landing Terminals Per Channel		2 Pairs			2 Pairs		
Array Wiring Termination		Terminal block, Pressure Clamp, AWG8-AWG4					
Output Side (AC)							
Grid Connection Type		1Ø/2W	Split-Ø/3W	1Ø/2W	1Ø/2W	Split-Ø/3W	1Ø/2W
Adjustable Voltage Range (V <sub>min</sub> -V <sub>max</sub> )	V	183-228	211-264	244-304	183-228	211-264	244-304
Grid Frequency	Hz	60			60		
Adjustable Grid Frequency Range	Hz	57-60.5			57-60.5		
Maximum Current (I <sub>acmax</sub> )	A <sub>RMS</sub>	27	23	20	30	28	24
Power Factor		> 0.995			> 0.995		
Total Harmonic Distortion At Rated Power	%	< 2			< 2		
Contributory Fault Current**	A <sub>pf</sub> /A <sub>RMS</sub>	36.25/25.63	36.5/25.81	31.75/22.45	36.25/25.63	36.5/25.81	31.75/22.45
Grid Wiring Termination Type		Terminal block, Pressure Clamp, AWG8 - AWG4					
Protection Devices							
Input							
Reverse Polarity Protection		Yes			Yes		
Over-Voltage Protection Type		Varistor, 2 for each channel			Varistor, 2 for each channel		
PV Array Ground Fault Detection		Pre start-up Riso and dynamic GFDI (Requires Floating Arrays)			Pre start-up Riso and dynamic GFDI (Requires Floating Arrays)		
Output							
Anti-Islanding Protection		Meets UL 1741/IEEE1547 requirements			Meets UL 1741/IEEE1547 requirements		
Over-Voltage Protection Type		Varistor, 2 (L <sub>1</sub> - L <sub>2</sub> / L <sub>1</sub> - G)			Varistor, 2 (L <sub>1</sub> - L <sub>2</sub> / L <sub>1</sub> - G)		
Maximum AC OCPD Rating	A	35	30	25	40	35	30
Efficiency							
Maximum Efficiency	%	97.1			97.1		
CEC Efficiency	%	96	96.5	96.5	96	96.5	96.5
Operating Performance							
Stand-by Consumption	W <sub>RMS</sub>	< 8			< 8		
Night time consumption	W <sub>RMS</sub>	< 0.6			< 0.6		
Communication							
User-Interface		16 characters x 2 lines LCD display					
Remote Monitoring (1xRS485 incl.)		AURORA-UNIVERSAL (opt.)					
Wired Local Monitoring (1xRS485 incl.)		PVI-USB-RS485_232 (opt.), PVI-DESKTOP (opt.)					
Wireless Local Monitoring		PVI-DESKTOP (opt.) with PVI-RADIOMODULE (opt.)					
Environmental							
Ambient Air Operating Temperature Range	°F (°C)	-13 to +140 (-25 to +60)			-13 to +140 (-25 to +60) with derating above 122 (50)		
Ambient Air Storage Temperature Range	°F (°C)	-40 to 176 (-40 to +80)			-40 to 176 (-40 to +80)		
Relative Humidity	% RH	0-100 condensing			0-100 condensing		
Acoustic Noise Emission Level	db (A) @1m	< 50			< 50		
Maximum Operating Altitude without Derating	ft(m)	6560 (2000)			6560 (2000)		
Mechanical Specifications							
Enclosure rating		NEMA 4X			NEMA 4X		
Cooling		Natural Convection			Natural Convection		
Dimensions (H x W x D)	in (mm)	41.4 x 12.8 x 8.6 (1052 x 325 x 218)					
Weight	lb (kg)	< 59.5 (27.0)			< 59.5 (27.0)		
Shipping Weight	lb (kg)	< 78 (35.4)			< 78 (35.4)		
Mounting System		Wall bracket			Wall bracket		
Conduit Connections		Trade Size Kos: (2ea x 1/2") and (2ea x 1-1/4"; 3 places side, front, rear)			Trade Size Kos: (2ea x 1/2") and (2ea x 1-1/4"; 3 places side, front, rear)		
DC Switch Rating (Per Contact)	A/V	25 / 600			25 / 600		
Safety							
Isolation Level		Transformerless (Floating Array)			Transformerless (Floating Array)		
Safety and EMC Standard		UL 1741, CSA - C22.2 N. 107.1-01			UL 1741, CSA - C22.2 N. 107.1-01		
Safety Approval		cCSAus			cCSAus		
Warranty							
Standard Warranty	years	10			10		
Extended Warranty	years	15 & 20			15 & 20		
Available Models							
Standard - With DC Switch - Floating Array		PVI-5000-OUTD-US			PVI-6000-OUTD-US		
Standard - With DC Switch - Floating Array and Arc Fault Detection (AFD)		PVI-5000-OUTD-US-A			PVI-6000-OUTD-US-A		

\* All data is subject to change without notice

\*\*Inverter can apply that much current – Breaker will open

### 7.1.1 VOLTAGE AND FREQUENCY LIMITS

The UL1741 requires the following voltage and frequency limits for utility interaction:

Table 7- 1: Voltage and Frequency Simulated Utility Source Limits

Condition	Simulated utility source		Maximum time (sec) at 60 Hz before cessation of current to the simulated utility
	Voltage (V)	Frequency (Hz)	
A	$V < 50\% V_{nom} (**)$	Rated (Default/Fixed)	0.16 sec (Fixed)
B	$50\%V_{nom} \leq V < 88\% V_{nom}$	Rated	2 sec (Fixed)
C	$110\%V_{nom} \leq V < 120\% V_{nom} (*)$	Rated	1 sec (Fixed)
D	$V \geq 120\% V_{nom} (*)$	Rated (Default, Fixed)	0.16 sec (Fixed)
E	Rated	$f > 60.5$ (Default)	0.16 sec (Default)
F	Rated	$f < 59.3$ (Default) (Adj. Set Points 59.7 Hz to 57 Hz)	0.16 sec (Default) (Adj. Set Points 0.16s to 300s)
G	Rated	$f < 57.0$ (Default, Fixed)	0.16 sec (Fixed)
H	Rated	$f > 60.5$ (Fixed)	0.16 sec (Fixed)

(\*) Note: For model at 277V High Voltage is fixed at 110% Vnom and Very High Voltage is fixed at 111% Vnom.

(\*\*)Note: for model at 208V Very Low Voltage is fixed at 55% Vnom. Minimum adjustable Low Voltage level is 55% Vnom.

### 7.1.2 EFFICIENCY CURVES

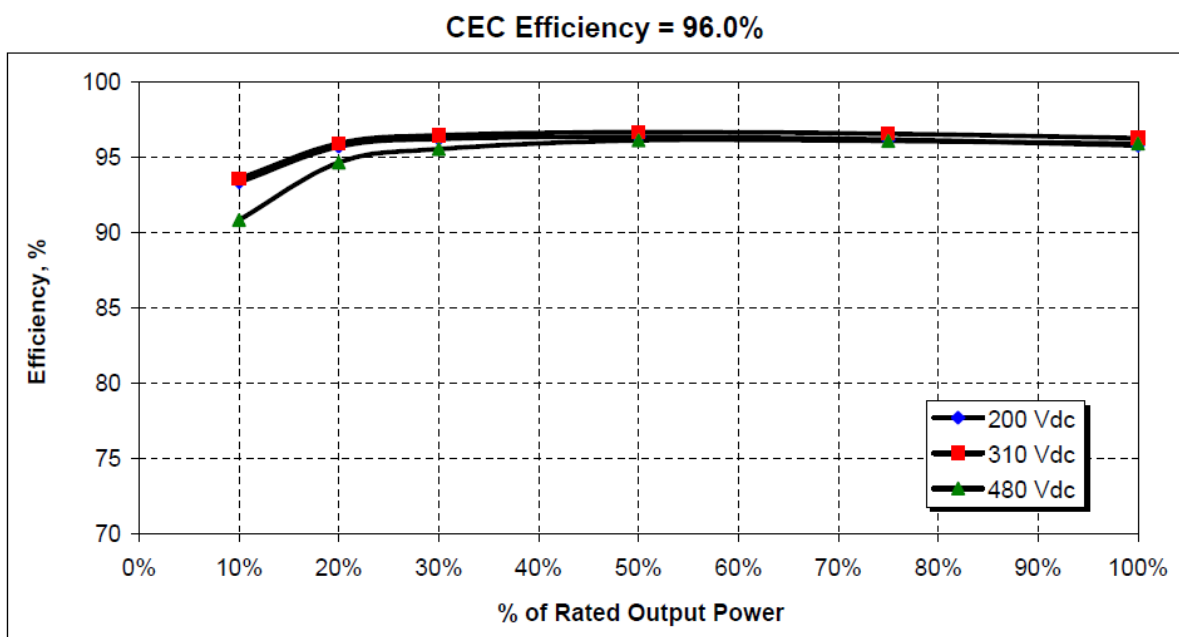

Figure 7-1: Efficiency Curve PVI-6000-OUTD-TL-US

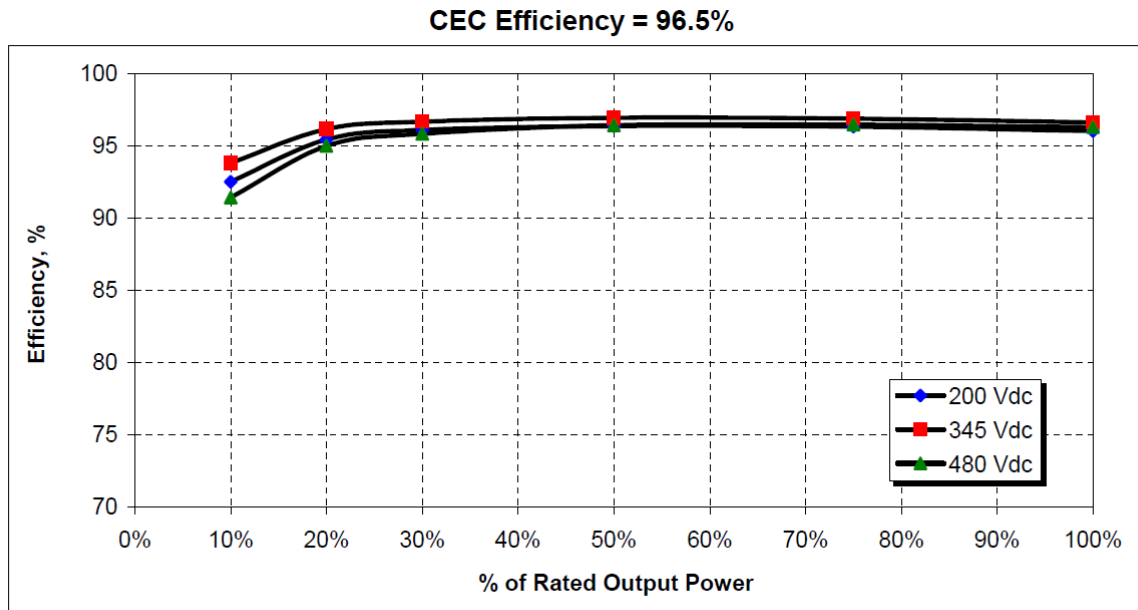

Figure 7-2: Efficiency Curve- PVI-5000-OUTD-US (240V)

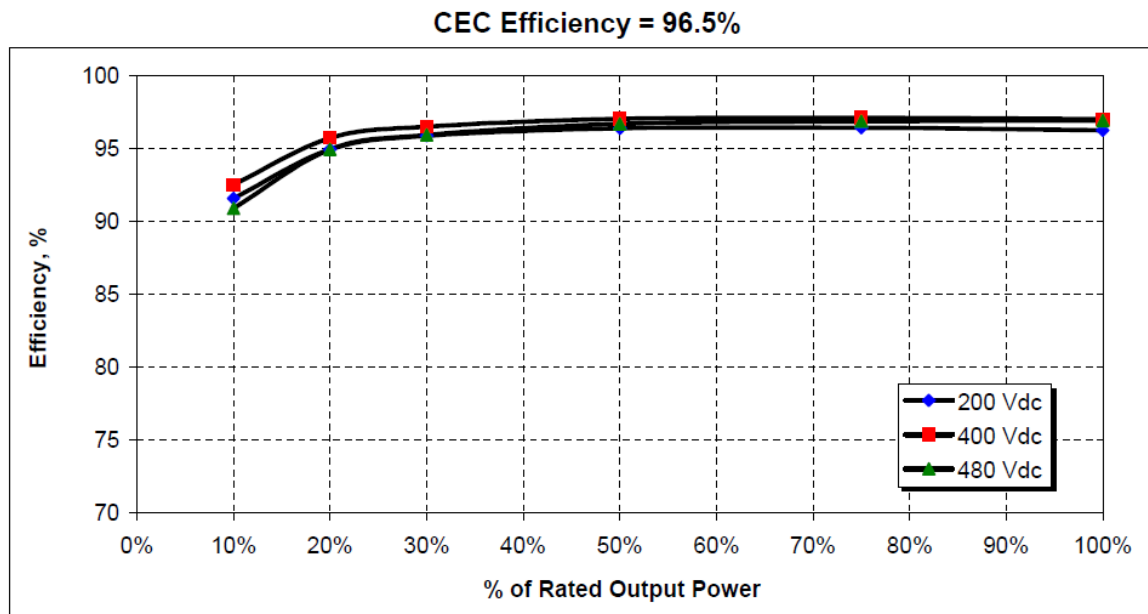

Figure 7-3: Efficiency Curve- PVI-5000-OUTD-US (277V)

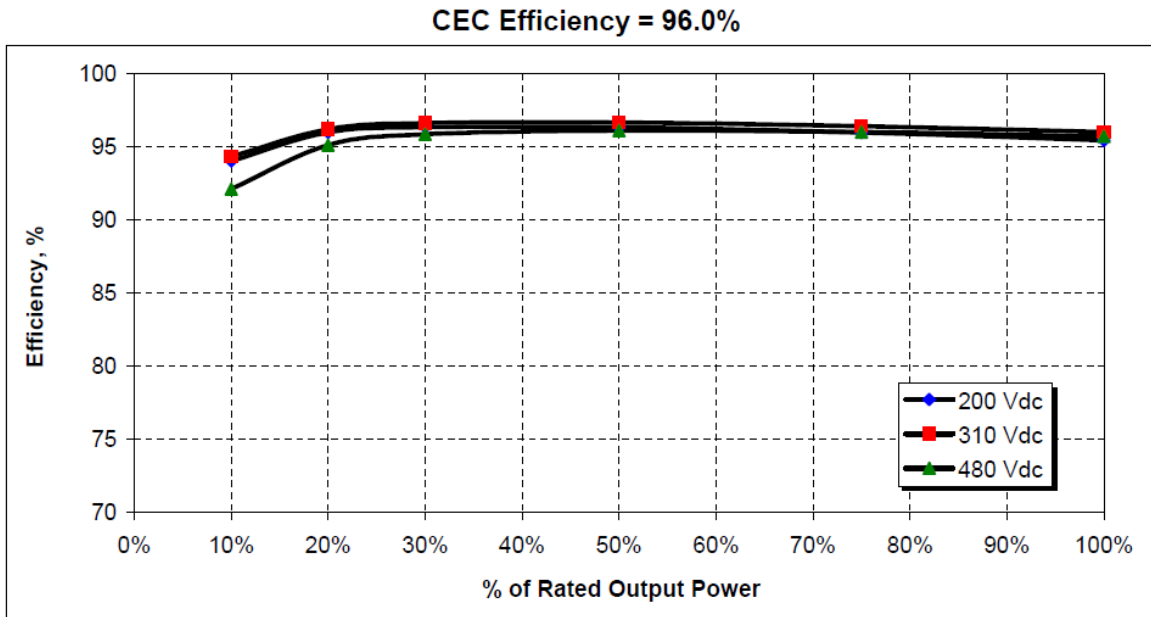

Figure 7-4: Efficiency Curve- PVI-6000-OUTD-US (208V)

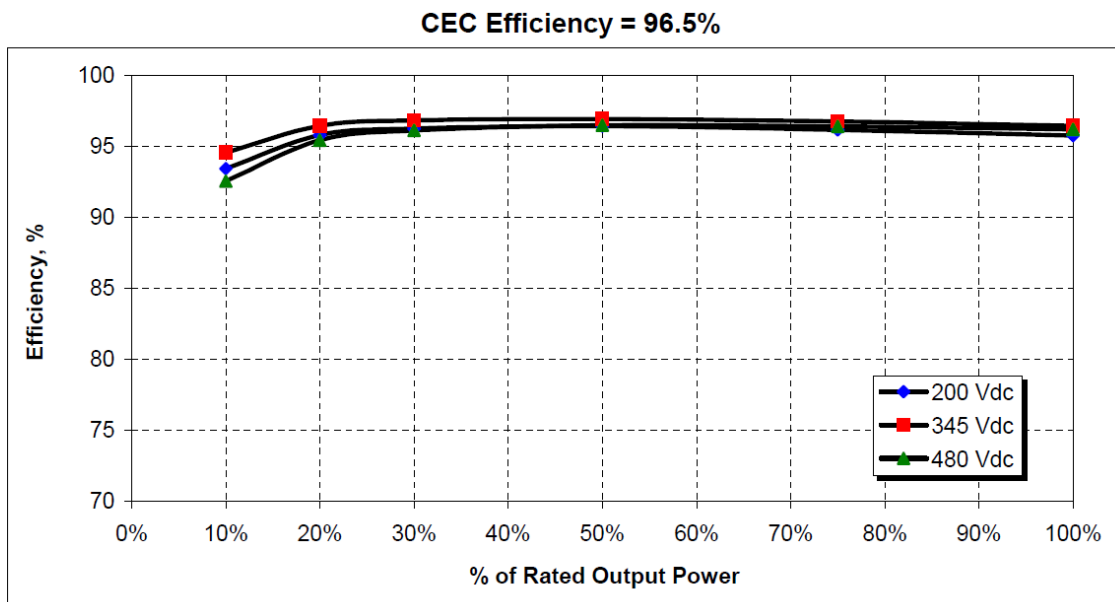

Figure 7-5: Efficiency Curve- PVI-6000-OUTD-US (240V)

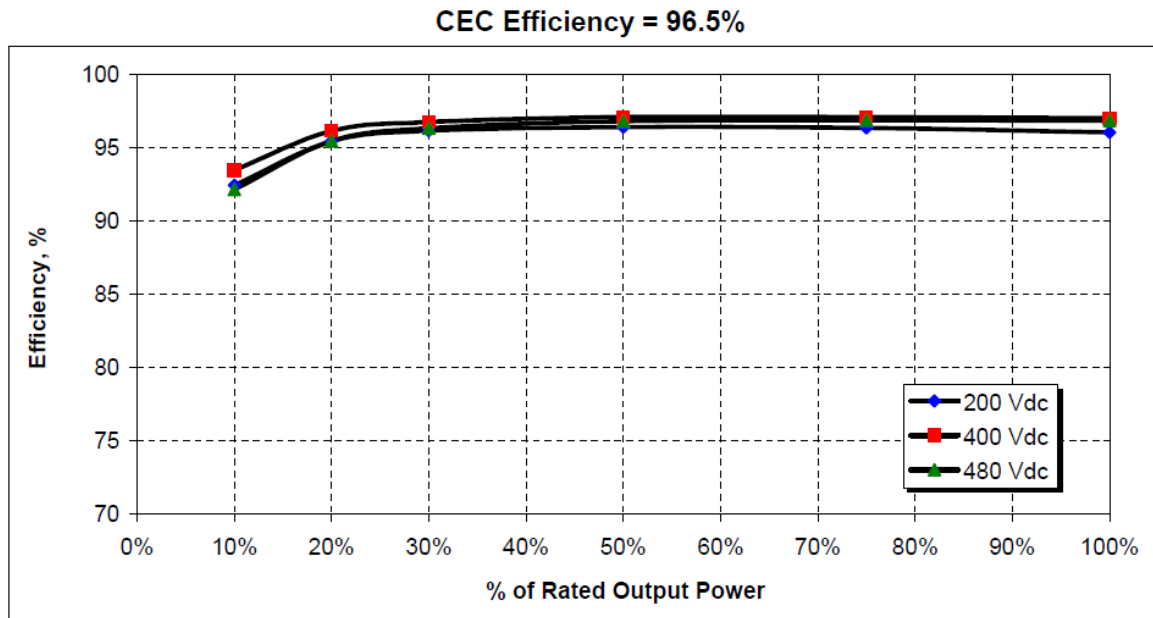

Figure 7-6: Efficiency Curve- PVI-6000-OUTD-US (277V)

### 7.1.3 POWER DERATING

In order to ensure inverter operation under safe conditions both from the temperature and electrical point of view, the unit automatically decreases power input to the grid. Power derating can occur in two cases:

#### Power reduction due to environmental conditions

Power reduction and temperature at which it occurs depend on many operating parameters other than ambient temperature, such as input voltage, grid voltage, and power available from the photovoltaic panels. The Aurora inverter can thus decrease power output during certain periods of the day according to these parameters.

In any case, the inverter ensures top power up to 40°C ambient temperature, when it is not directly exposed to the sun.

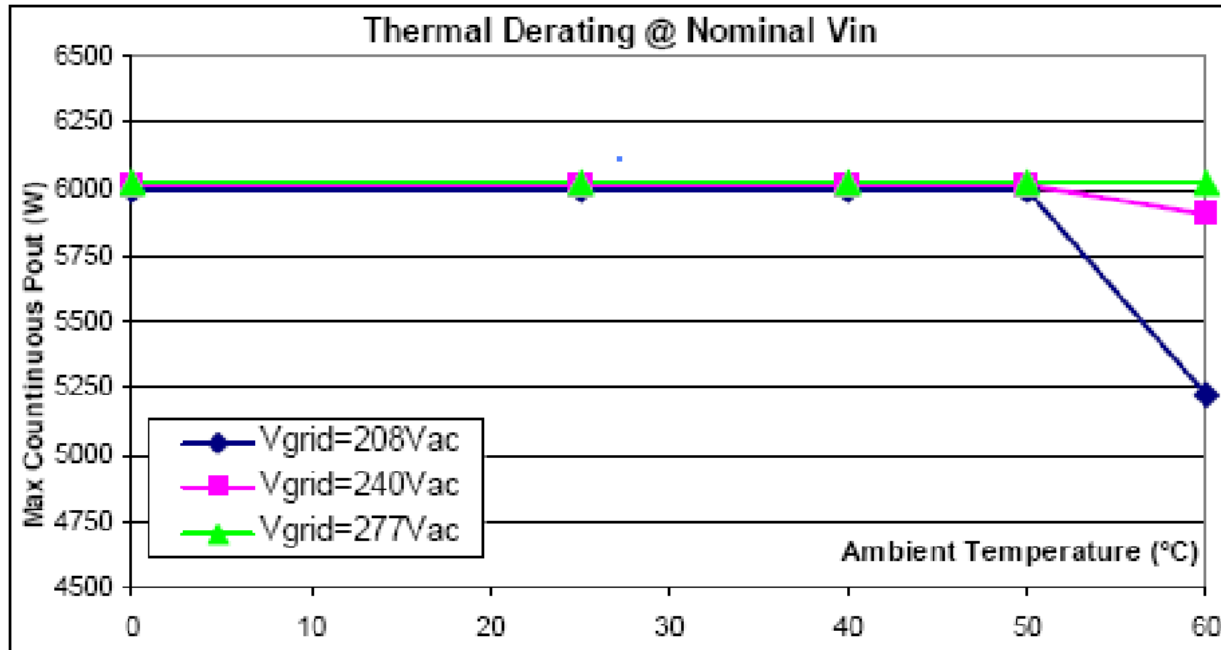

Figure 7-7: Aurora operating ambient temperature at full power (without derating) -25°C...+50°C for PVI-6000-OUTD-US

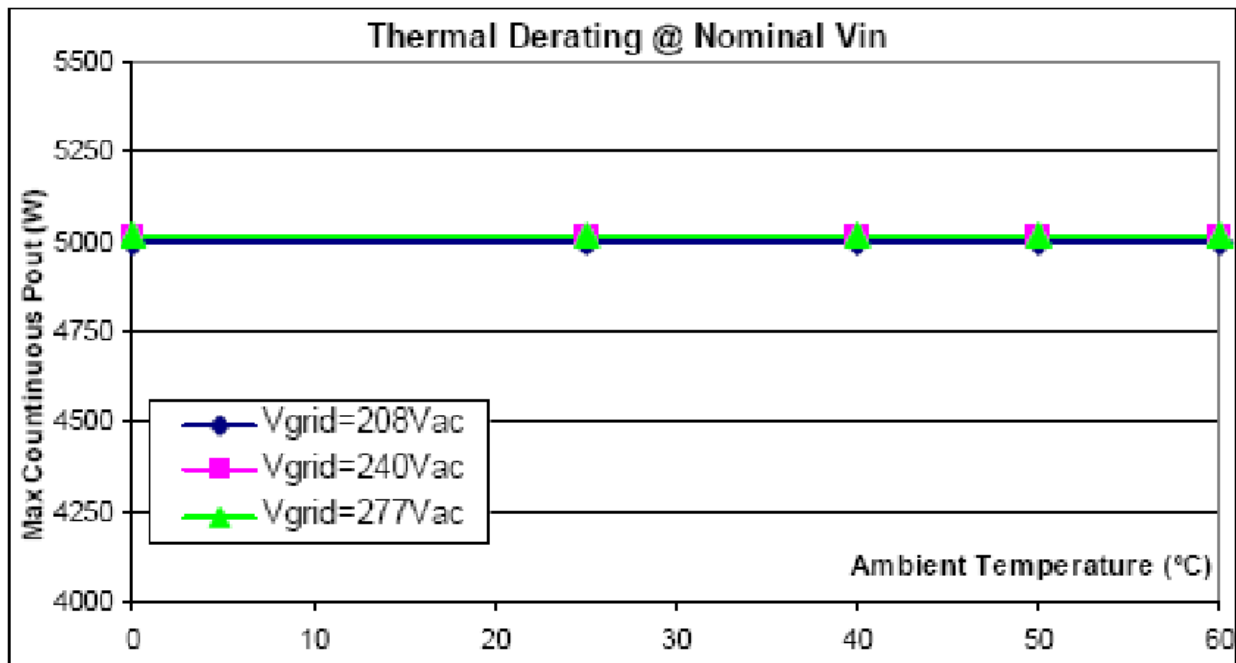

Figure 7-8: Aurora operating ambient temperature at full power (without derating) -25°C +60°C for PVI-5000-OUTD-US

### Power reduction due to input voltage

The graph BELOW shows automatic power output derating when input or output voltage is too high or too low.

Necessary conditions for power derating due to environmental conditions and to input voltage can occur at the same time, but in this instance power derating will always consider the lowest value detected.

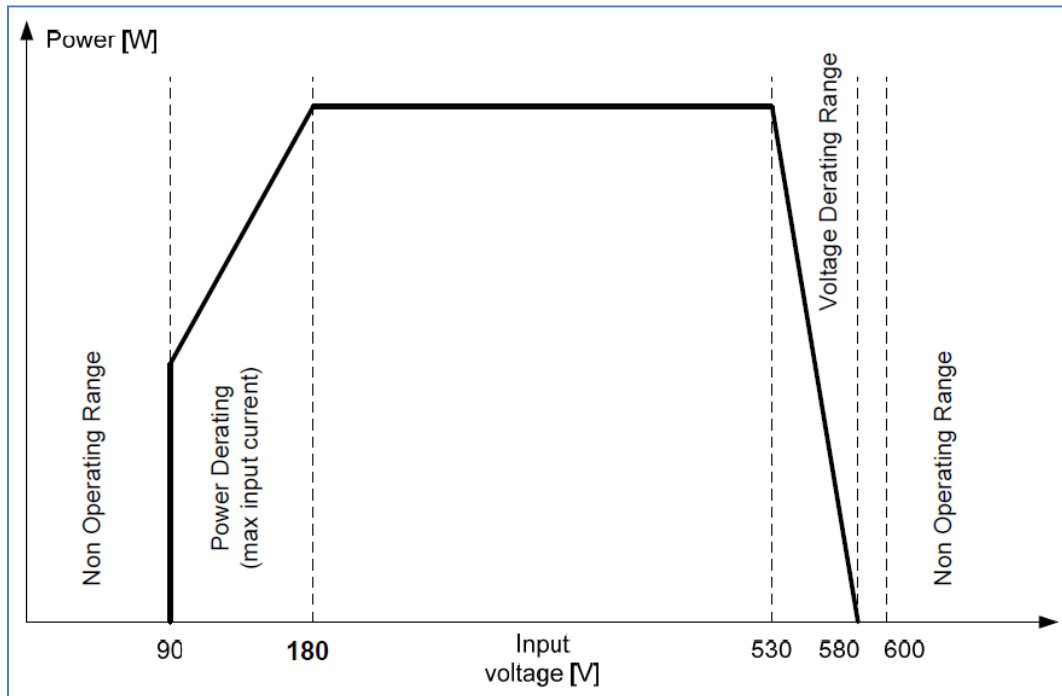

Figure 7-9: Output Power – Two DC Sections Operating

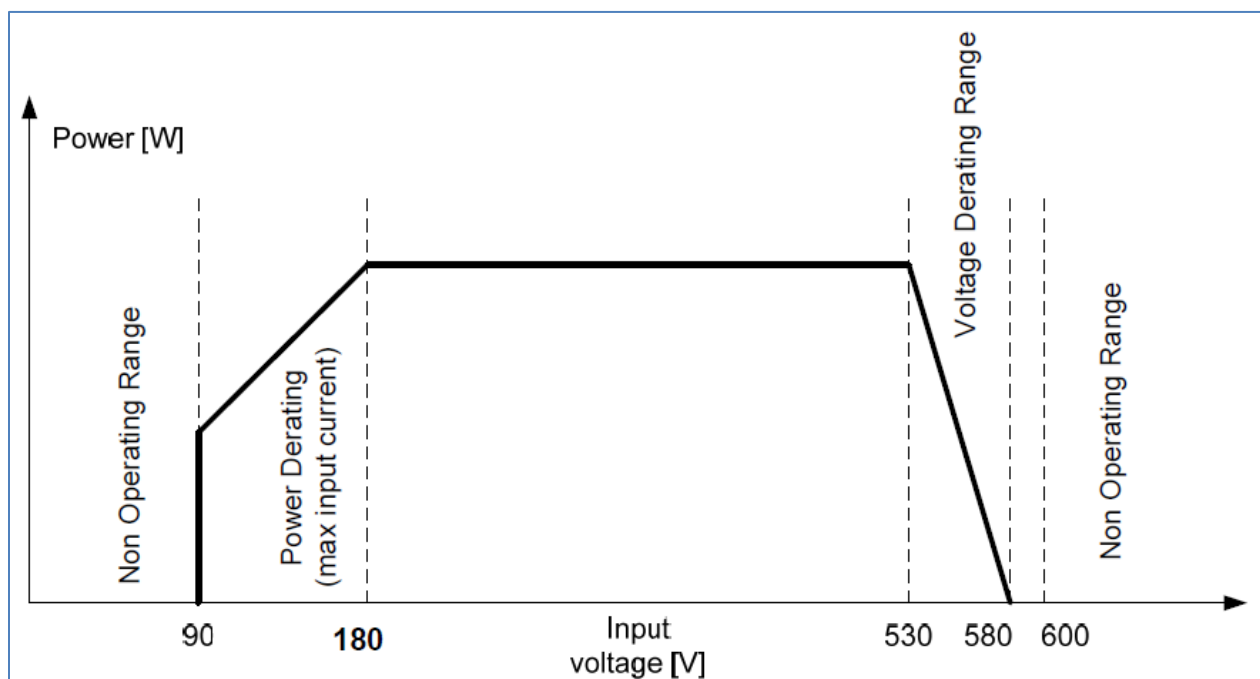

Figure 7-10: Output Power – One DC Section Operating



## 7.2 SYSTEM DESCRIPTION

AURORA UNO grid-tied inverters provide the capability to supply the utility grid with energy obtained from PV panels. To use the DC generated by a Photovoltaic field efficiently, it must be transformed into alternating current (AC) via a conversion process known as DC-AC inversion.

This process is the basis of all grid-tied inverters and is achieved very efficiently by the AURORA Inverter without the use of rotating elements. When the inverter output is connected in parallel to the utility power grid, the alternating current output from the inverter flows directly into the distribution circuit, and is connected in turn to the public distribution utility grid.

The photovoltaic energy system can thus feed all the connected user electrical loads:

- If the energy supply from the photovoltaic system is lower than the user's load requirement, the quantity of energy necessary to guarantee normal functioning of the connected appliances is taken from the public distribution network.
- If the energy supply from the photovoltaic system is greater than the user's load requirement (i.e. an excess of energy is produced) it is sent directly into the public network, thus becoming available to other users.

Depending on prevailing codes and regulations of the installation area, the energy produced can be sold to the utility or credited against future consumption, thereby producing energy savings.

### 7.2.1 ELEMENTS OF A PHOTOVOLTAIC SYSTEM: 'STRINGS' AND 'ARRAYS'

In order to significantly reduce installation costs of the photovoltaic system, especially related to the wiring problem on the inverter DC side and the subsequent distribution on the AC side, the STRING technology was developed. The terminology is as follows:

1. A photovoltaic panel is composed of a great number of photovoltaic cells fixed onto a single supporting base.
2. A STRING consists of a certain number of panels connected in series.
3. An ARRAY is one or more strings connected in parallel.

Large photovoltaic systems can be composed of several arrays, connected to one or more AURORA Inverters. By maximizing the number of panels in each string, the cost and complexity of the connection systems of the plant can be reduced.

### 7.2.2 INVERTER INPUT - THE PHOTOVOLTAIC ARRAY

The input of a photovoltaic (PV) inverter is intended to be connected to a PV array. The input circuitry includes Maximum Power Point Tracking (MPPT) circuitry, which maximizes the output of the PV array under all allowable environmental conditions.

All AURORA UNO models are provisioned with two independent inputs, each equipped with its own MPPT circuit that enables the AURORA UNO Inverter to be connected to two independent arrays that are maximized for output power individually. See Block Diagram in Figure 7-11 below.

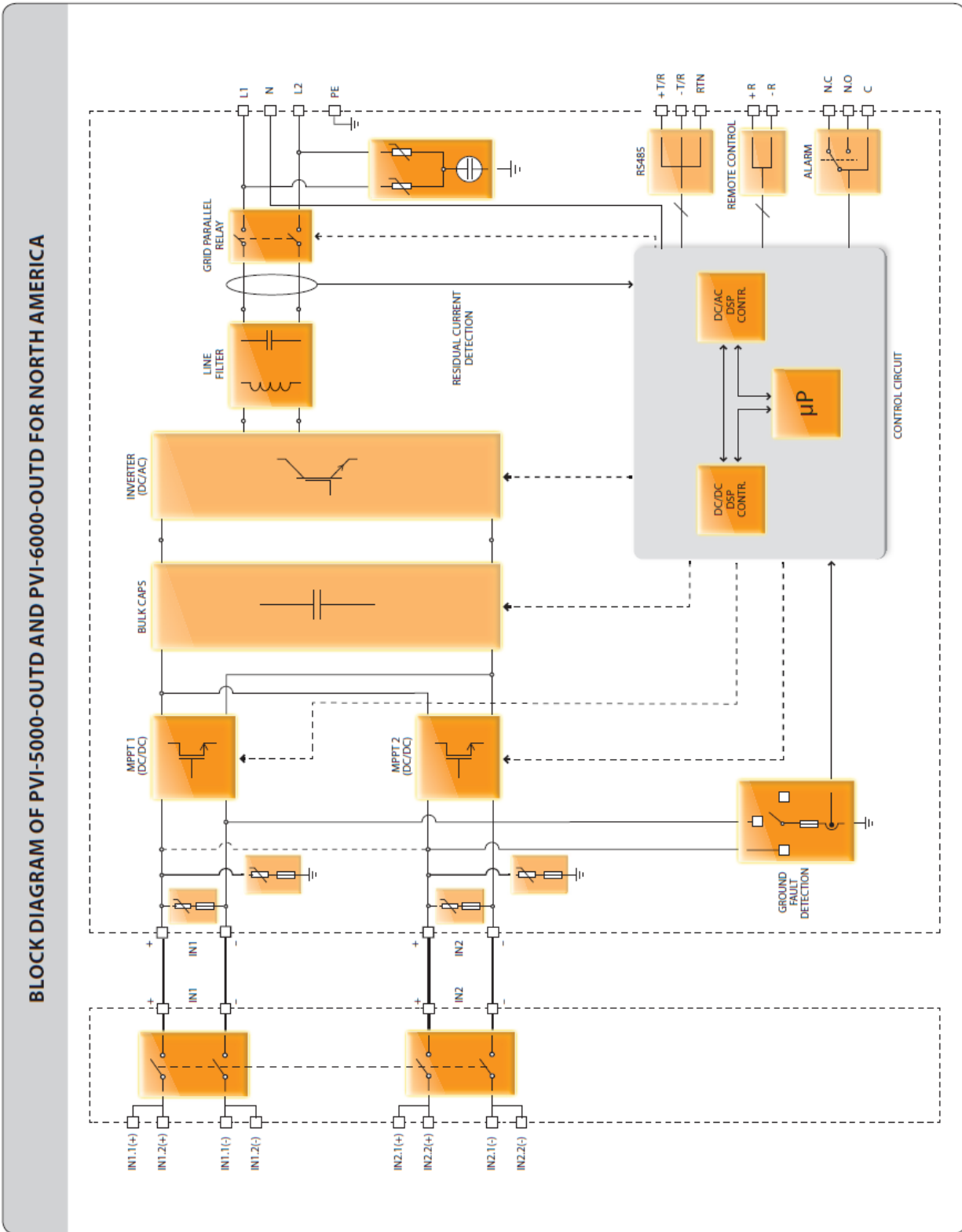

Figure 7-11: Block Diagram

The MPPT circuitry has a specific operating range and the arrays must be designed to operate within this range. In order to properly operate the AURORA Inverter, proper array sizing must be completed and the results translated to a connectable system.

Array sizing is based on many variables and must be done for every array, as specifications are dependent on the type and quantity of PV panel used, and environmental factors such as expected high and low ambient temperatures to which the array will be subjected, as well as the orientation of the array panels to the sun.

In addition to properly sizing the array to match the inverter to which it is connected, the sizing of the interconnecting wiring is critical to ensure safe operation and high reliability. In North America, the wire sizing for the array and the grid interconnection are regulated and controlled by electric and building codes.

Generally in the US, the National Electric Code (NEC) is used, but some areas use variations to this code. In Canada, the national code is the Electrical Safety Code (ESC); however, there are also local variations to this code (e.g., in Ontario the Ontario Electrical Safety Code (OESC) is the regulating document). The sizing and specification of a PV array requires trained individuals.

Decisions on how to structure a photovoltaic array depend on a number of factors and considerations, such as the type of panels, the available space, the future location of the system, long-term energy production targets, etc. Power-One offers a configuration program (AURORA Stringtool) that can aid the designer in setting correct dimensioning of a photovoltaic array to match characteristics of AURORA Inverters is available on the Power-One website (<http://stringtool.power-one.com/>).

**To avoid equipment damage, the string voltage must not exceed 520 Vdc for any reason.**



**The effect of the negative thermal coefficient on the PV module's open circuit voltage causes Over Current (OC) Voltage to occur in conditions of minimum ambient temperature. It is the responsibility of the installer to check the PV generator's configuration before connecting any PV array.**

**The AURORA Inverter has a maximum allowable input short circuit current limit of the PV string of 22 Adc for each MPPT input channel.**



**The default value of the input voltage required to start the inverter (Vstart) is 200 Vdc; however, this can be set from the control panel over the range between 120 Vdc and 350 Vdc. This voltage level is required for the AURORA Inverter to start its grid connection sequence.**

**Once connected, the inverter will transfer the maximum available power for any Vdc input voltage value in a range between 70% of the value set by Vstart and 580 Vdc to the grid.**

### 7.2.3 NOTES ON DIMENSIONING OF THE SYSTEM

Decisions about how to structure a photovoltaic system depend on a certain number of factors and considerations to meet the type of panels, the availability of space, the future location of the system, energy production goals over the long term, etc.

A configuration program that can help to correctly size the photovoltaic system is available on the Power-One website at [www.power-one.com](http://www.power-one.com).

## 7.2.4 TECHNICAL DESCRIPTION OF AURORA INVERTER

The main segments of the design are the independent input DC-DC converters (termed 'boosters', one for each MPPT channel) and the main output inverter. Both of the DC-DC converters and the output inverter operate at a high switching frequency to enable a compact design and low weight.

These versions of Power-One's AURORA Inverters utilize "high-frequency switching" transformers, to provide a high-level of galvanic isolation between inverter input (array) and output (grid). This circuitry provides galvanic isolation from the secondary (AC side), while maintaining very high performance in terms of energy yield and export.

An AURORA with two independent input DC-DC converters; each converter is typically dedicated to a separate array and has independent Maximum Power Point Tracking (MPPT) circuitry and control. This means that the two arrays can be installed with different positions, facing different directions and with different string lengths; each array is controlled by an MPPT control circuit.

The Aurora's high efficiency and extra large heat dissipation system enables operation at maximum power over a broad range of ambient temperatures. Two independent *Digital Signal Processors* (DSP) and one central microprocessor control the inverter; and therefore, two independent computers control the grid connection in full compliance with safety standards and regulations.

The AURORA Inverter operating system (program) communicates with all of the sub-systems within the inverter performing necessary data processing, calculations to guarantee optimal performance levels of the system and high-power harvesting in all installation and load conditions, while maintaining full compliance with prevailing safety directives, laws and regulations.

## 7.2.5 PROTECTIVE DEVICES WITHIN THE AURORA INVERTER

### 7.2.5.1 *Inverter Output - the Grid Connection*

The inverter converts energy harvested from the PV array into a form that can be transported to the connected AC grid, and by doing so, enables the energy to be used to power grid-loads.

Connections of an inverter to the grid is a very controlled process not only in the actual electrical connection, but the regulatory processes required to gain approval from the controlling utility and other regulatory bodies. AURORA UNO Inverters meet the requirements of all interconnection standards.

### 7.2.5.2 *Data Transmission and Check*

The AURORA Inverters have a sophisticated communication capability that enables monitoring of single or multiple inverters over a single communication link. Remote monitoring is implemented over an RS-485-based serial interface using a version of the AURORA Protocol. There is an optional web-based data logging system (AURORA Universal) also available for remote monitoring via the Internet via LAN, or GSM digital modem. The PVI-Desktop is another monitoring option that enables (with the use of the PVI-Radio-module installed in each inverter) the ability to monitor wirelessly operation of up to six inverters within a 1000-foot radius. The PVI desktop is not a web-based monitoring system and is intended for local ("in-house") monitoring applications.

### 7.2.5.3 *Anti-Islanding*

When the local utility AC grid fails due to a line fault or otherwise interrupted (e.g., equipment maintenance) the AURORA UNO Inverter must be physically disconnected in a fail-safe manner to protect any personnel working on the network. The AURORA system accomplishes this in full compliance with all prevailing standards and regulations. To avoid any possible operation without the presence of an active grid connection, the AURORA

design includes an automatic disconnection protection system called 'Anti-Islanding'. All AURORA models are equipped with an anti-islanding protection system certified to both US and Canadian standards (UL Std N.1741 and CSA-C22.2 N.107.1-01)

#### 7.2.5.4 *Grounding/Differential Protection Fault*

AURORA UNO Inverter has a sophisticated ground protection circuit that continually monitors the ground connection for significant changes in fault current. when a ground fault current sufficient to cause safety hazards is detected, this circuit shuts down the inverter and illuminates a red LED on the front panel indicating a ground fault condition. The AURORA Inverter is equipped with a terminal for the system ground conductors.



**Normally grounded conductors may be ungrounded and energized when a ground-fault is indicated resulting in risk of electric shock. Test before touching.**

**Work on the AURORA UNO Inverter must be carried out by qualified personnel.**

**NOTE:** The protective devices for ground fault detection and control comply with CSA-C22.2 N.107.1-01 and UL Std N.1741.

#### 7.2.5.5 *Additional Protective Devices*

AURORA UNO Inverter is equipped with additional protections to guarantee the safe operation under any circumstances. Such protections include:

- Constant monitoring of grid voltage to ensure that voltage and frequency remain within the specified operational limits (in accordance with UL 1741 standard);
- Automatic power limitation (derating) controlled by internal temperature monitoring to avoid overheating (heat sink temperature  $\geq 158^{\circ}\text{F}$ ).

#### 7.2.5.6 *Arc Fault Detector (AFD)*

This safety function allows the inverter to recognize electrical arcing on DC cables. Once the arcing has been detected the inverter will fall into secure state. The inverter will remain in this disconnected state even after turn it off and on again. It's possible to unlatch the unit pressing 'ESC' button on the display after a complete check of DC cables.

### 7.2.6 FCC REMARKS

The equipment specified in this manual complies with Part 15 of the FCC rules. Operation is subject to following two conditions:

- This equipment may not cause harmful interference.
- This equipment must accept any interference received, including interference that may cause undesired operation.

### 7.3 INDEX OF FIGURES AND TABLES

Table 1-1: Available versions .....	10
Figure 1-1: Sample nameplate for PVI-5000-OUTD-US .....	10
Figure 1-2: Sample product label.....	11
Table 2-1: Package Contents .....	12
Figure 2-1: Minimum Clearances around the AURORA Inverter .....	13
Figure 2-2: Side-by-side arrangement with minimum clearances around the AURORA Inverter .....	14
Figure 2-3: Staggered arrangement avoiding heat from other inverters .....	14
Figure 2-4: Outdoor installation examples .....	15
Figure 3-1: Bracket and Mounting Details .....	16
Figure 3-2: Front Access Panel Location .....	18
Figure 3-3: DC switchbox with front switch external chassis view .....	19
Figure 3-4: DC switchbox with bottom switch external chassis view .....	19
Table 3-1: Switchbox External Parts Summary .....	19
Figure 3-5: Switch Box DC Electrical Schematics - *AFD available on –A models only .....	20
Figure 3-6: Front switch – wiring box details.....	20
Figure 3-7: Bottom switch – wiring box details .....	20
Figure 3-8: Front switch – wiring box details with AFD .....	21
Table 3-2: Switchbox Internal Parts Summary.....	21
Table 3-3: Bottom switch torque values for terminal bloc and ground lug.....	22
Figure 3-9: Main Inverter Connection Board.....	22
Figure 3-10: Electrical connection diagram .....	23
Figure 3-11: Front switch Independent configuration.....	24
Figure 3-12: Bottom switch Independent configuration .....	24
Figure 3-13: S1 Switch in IND position (independent mode) .....	25
Figure 3-14: S1 Switch in PAR position (parallel mode).....	25
Figure 3-15: Front switch jumpers parallel MPPT input configuration –S versions only .....	26
Figure 3-16: Bottom switch jumpers for parallel MPPT Configuration and Front switch –A versions only .....	26
Figure 3-17: Front switch AC Grid terminal .....	27
Figure 3-18: Bottom switch AC grid terminal .....	27
Table 3-4: AC Grid Standard .....	27
Table 3- 1: RJ45 Connectors .....	29
Figure 3-19: Standard RS485 connection .....	29
Figure 3-20: Data cable for use with RS-485 communications .....	30
Figure 3-21: Termination Switch S2.....	31
Figure 3-22: Daisy Chain Communication Wiring .....	31
Figure 4-1: Data Transmission Options.....	32
Figure 4-2: LED Indicators and Controls .....	34
Figure 4-3: Alarm and Remote Contacts Terminal Block.....	48
Figure 4-4: Configuration Panel.....	55
Figure 4-5: Select Mode Panel.....	55
Figure 4-6: Grid Parameters Panel.....	56
Table 4- 1: Voltage and Frequency Disconnect Parameters and associated -TL Manager Symbols .....	57
Table 5-1: Display Messages and Error Codes .....	59
Table 6-1: Recommended Periodic Maintenance .....	69
Figure 6- 1: Internal battery replacement .....	69
Table 6- 1: Component Disposal.....	70
Table 7-1: Technical Data .....	71
Table 7- 1: Voltage and Frequency Simulated Utility Source Limits .....	72
Figure 7-1: Efficiency Curve PVI-6000-OUTD-TL-US.....	72
Figure 7-2: Efficiency Curve- PVI-5000-OUTD-US (240V).....	73
Figure 7-3: Efficiency Curve- PVI-5000-OUTD-US (277V).....	73
Figure 7-4: Efficiency Curve- PVI-6000-OUTD-US (208V).....	74

Figure 7-5: Efficiency Curve- PVI-6000-OUTD-US (240V)..... 74  
 Figure 7-6: Efficiency Curve- PVI-6000-OUTD-US (277V)..... 75  
 Figure 7-7: Aurora operating ambient temperature at full power (without derating) -25°C...+50°C for PVI-6000-OUTD-US..... 76  
 Figure 7-8: Aurora operating ambient temperature at full power (without derating) -25°C +60°C for PVI-5000-OUTD-US..... 76  
 Figure 7-9: Output Power –Two DC Sections Operating ..... 77  
 Figure 7-10: Output Power – One DC Section Operating ..... 77  
 Figure 7-11: Block Diagram..... 79

<i>Revision Number</i>	<i>Author</i>	<i>Date</i>	<i>Description of Modification</i>
1.0	Italy	11/19/07	New release
1.1	Italy	12/15/08	US added
2.0	Italy	3/17/09	Certificate of Compliance added
2.1	Italy	6/26/00	Modified allowed cable section
BCG.00565 NA 1.0, Rev AA	Tech docs	4/5/12	8 ½ X 11 size for NA
BCG.00682 NA 2.0 Rev AA	Tech Docs	6/08/2013	Combined manual for front-facing and bottom DC switch. Incorporated addendums BCG.00025; BCA.00016; BCG.00607; BCG.00648. Added part number and description of AFD
BCG.00682 NA 2.1 Rev AA	Tech Docs	7/09/2013	Changed knockout sizes for switchbox
BCG.00682 NA 2.2 Rev AA	Tech Docs	8/29/2013	Corrected REMOTE CONTROL ON/OFF instructions, p54